

W5500 Datasheet

Version 1.0.2



SKY↑TECH

تهیه و توزیع قطعات الکترونیک

 WIZnet

<http://www.wiznet.co.kr>

W5500

The W5500 chip is a Hardwired TCP/IP embedded Ethernet controller that provides easier Internet connection to embedded systems. W5500 enables users to have the Internet connectivity in their applications just by using the single chip in which TCP/IP stack, 10/100 Ethernet MAC and PHY embedded.

WIZnet's Hardwired TCP/IP is the market-proven technology that supports TCP, UDP, IPv4, ICMP, ARP, IGMP, and PPPoE protocols. W5500 embeds the 32Kbyte internal memory buffer for the Ethernet packet processing. If you use W5500, you can implement the Ethernet application just by adding the simple socket program. It's faster and easier way rather than using any other Embedded Ethernet solution. Users can use 8 independent hardware sockets simultaneously.

SPI (Serial Peripheral Interface) is provided for easy integration with the external MCU. The W5500's SPI supports 80 MHz speed and new efficient SPI protocol for the high speed network communication. In order to reduce power consumption of the system, W5500 provides WOL (Wake on LAN) and power down mode.

Features

- Supports Hardwired TCP/IP Protocols : TCP, UDP, ICMP, IPv4, ARP, IGMP, PPPoE
- Supports 8 independent sockets simultaneously
- Supports Power down mode
- Supports Wake on LAN over UDP
- Supports High Speed Serial Peripheral Interface(SPI MODE 0, 3)
- Internal 32Kbytes Memory for TX/RX Buffers
- 10BaseT/100BaseTX Ethernet PHY embedded
- Supports Auto Negotiation (Full and half duplex, 10 and 100-based)
- Not supports IP Fragmentation
- 3.3V operation with 5V I/O signal tolerance
- LED outputs (Full/Half duplex, Link, Speed, Active)
- 48 Pin LQFP Lead-Free Package (7x7mm, 0.5mm pitch)

Target Applications

W5500 is suitable for the following embedded applications:

- Home Network Devices: Set-Top Boxes, PVRs, Digital Media Adapters
- Serial-to-Ethernet: Access Controls, LED displays, Wireless AP relays, etc.
- Parallel-to-Ethernet: POS / Mini Printers, Copiers
- USB-to-Ethernet: Storage Devices, Network Printers
- GPIO-to-Ethernet: Home Network Sensors
- Security Systems: DVRs, Network Cameras, Kiosks
- Factory and Building Automations
- Medical Monitoring Equipment
- Embedded Servers



SKYTECH

تهیه و توزیع قطعات الکترونیک

Block Diagram

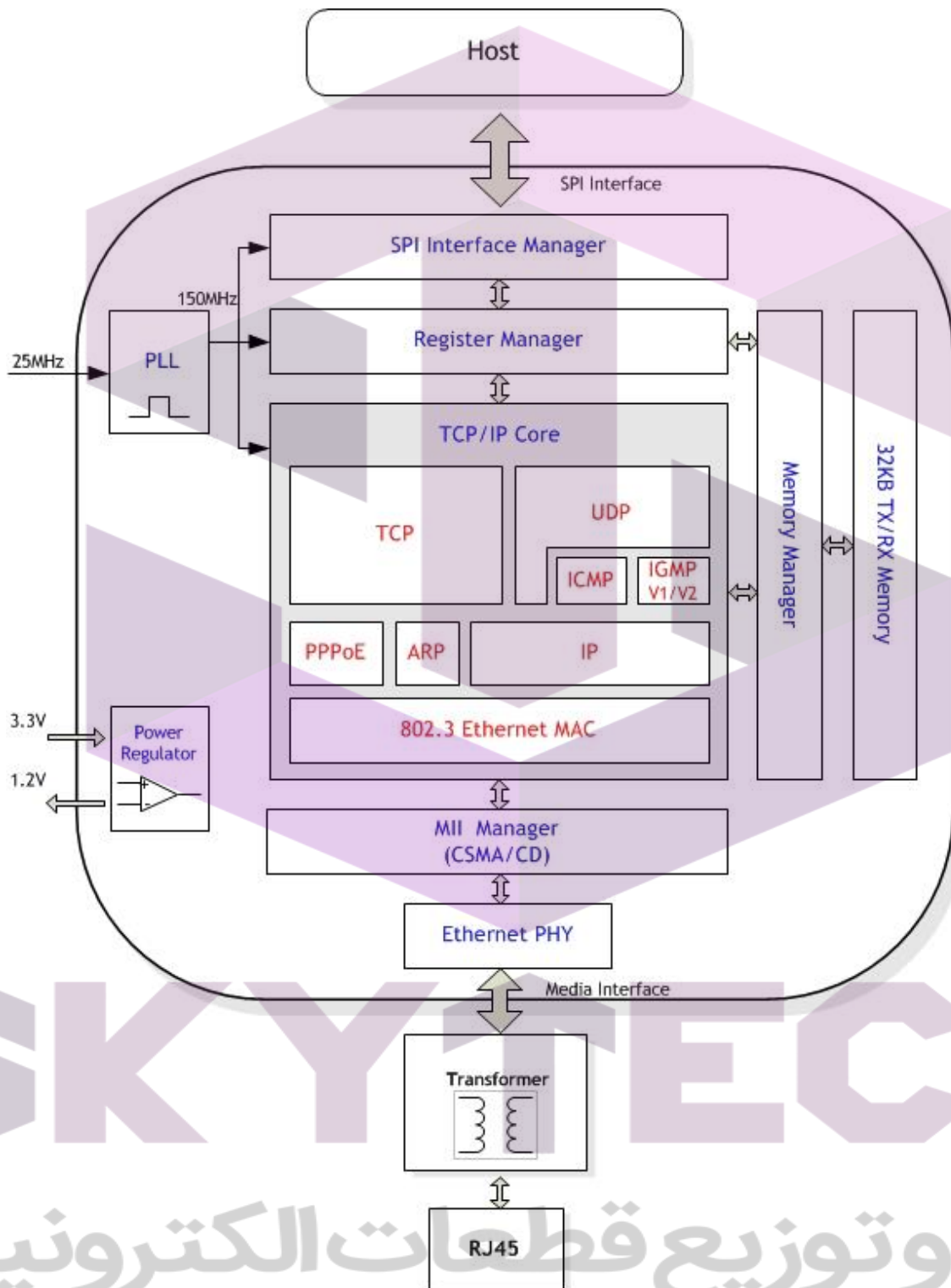

Table of Contents

1	Pin Assignment	7
1.1	Pin Descriptions	7
2	HOST Interface	12
2.1	SPI Operation Mode	13
2.2	SPI Frame	14
2.2.1	Address Phase	14
2.2.2	Control Phase	15
2.2.3	Data Phase	17
2.3	Variable Length Data Mode (VDM)	17
2.3.1	Write Access in VDM	18
2.3.2	Read Access in VDM	21
2.4	Fixed Length Data Mode (FDM)	24
2.4.1	Write Access in FDM	25
2.4.2	Read Access in FDM	26
3	Register and Memory Organization	27
3.1	Common Register Block	29
3.2	Socket Register Block	30
3.3	Memory	31
4	Register Descriptions	32
4.1	Common Registers	32
4.2	Socket Registers	44
5	Electrical Specifications	59
5.1	Absolute Maximum Ratings	59
5.2	Absolute Maximum Ratings (Electrical Sensitivity)	59
5.3	DC Characteristics	60
5.4	POWER DISSIPATION	61
5.5	AC Characteristics	61
5.5.1	Reset Timing	61
5.5.2	Wake up Time	61
5.5.3	Crystal Characteristics	61
5.5.4	SPI Timing	62
5.5.5	Transformer Characteristics	63
5.5.6	MDIX	63
6	Package Descriptions	64
	Document History Information	65

Table of Figures

Figure 1. W5500 Pin Layout	7
Figure 2. External reference resistor	11
Figure 3. Crystal reference schematic	11
Figure 4. Variable Length Data Mode (SCSn controlled by the host)	12
Figure 5. Fixed Length Data Mode (SCSn is always connected by Ground)	12
Figure 6. SPI Mode 0 & 3	13
Figure 7. SPI Frame Format	14
Figure 8. Write SPI Frame in VDM mode	18
Figure 9. SIMR Register Write in VDM Mode	19
Figure 10. 5 Byte Data Write at 1th Socket's TX Buffer Block 0x0040 in VDM mode..	20
Figure 11. Read SPI Frame in VDM mode	21
Figure 12. S7_SR Read in VDM Mode	22
Figure 13. 5 Byte Data Read at Socket 3 RX Buffer Block 0x0100 in VDM mode	23
Figure 14. 1 Byte Data Write SPI Frame in FDM mode.....	25
Figure 15. 2 Bytes Data Write SPI Frame in FDM mode	25
Figure 16. 4 Bytes Data Write SPI Frame in FDM mode	25
Figure 17. 1 Byte Data Read SPI Frame in FDM mode	26
Figure 18. 2 Bytes Data Read SPI Frame in FDM mode	26
Figure 19. 4 Bytes Data Read SPI Frame in FDM mode	26
Figure 20. Register & Memory Organization	28
Figure 21. INTLEVEL Timing	34
Figure 22. Reset Timing.....	61
Figure 23. SPI Timing.....	62
Figure 24. Transformer Type	63
Figure 25. Package Dimensions.....	64

SKYTECH

تهیه و توزیع قطعات الکترونیک

1 Pin Assignment

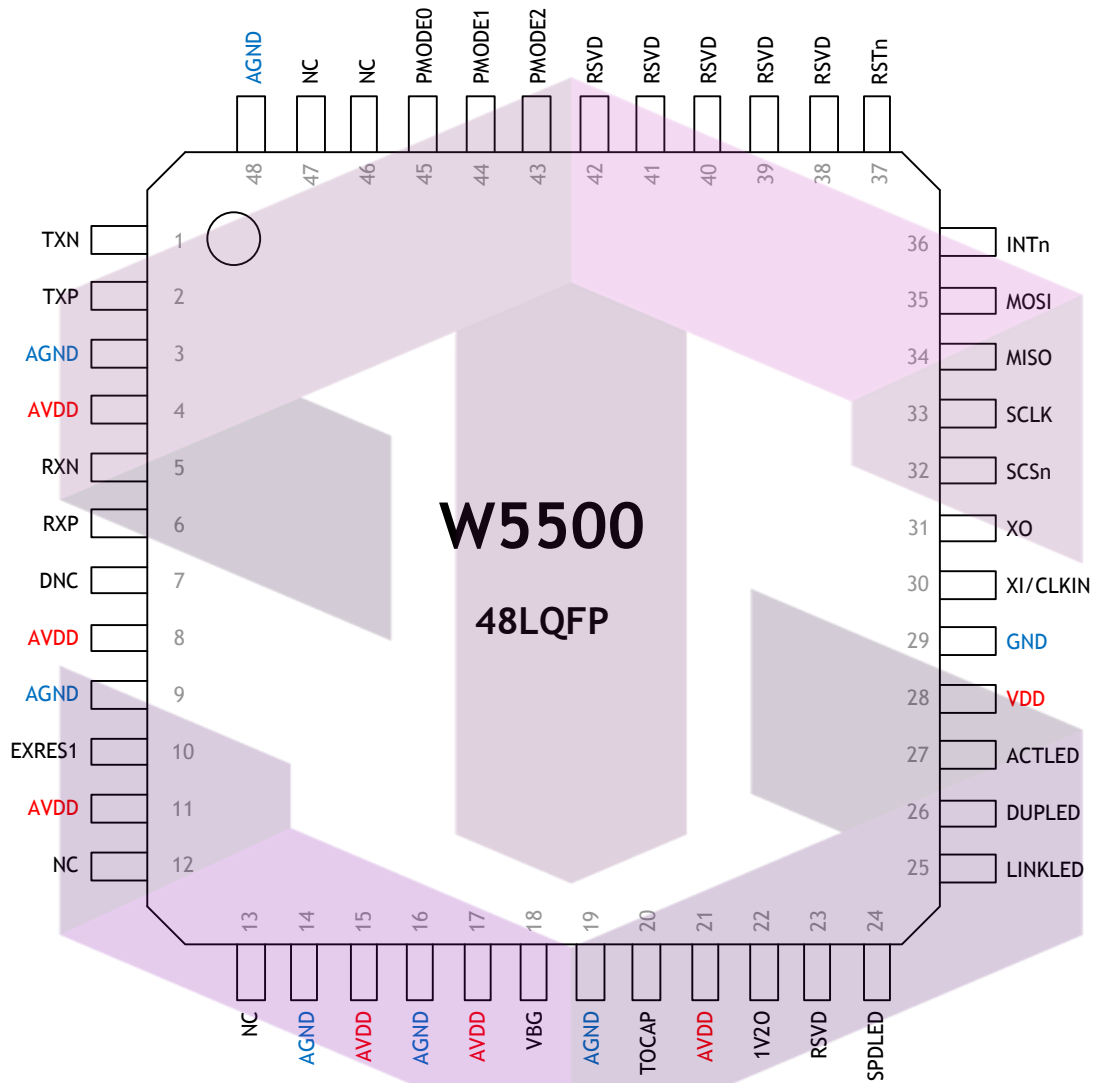

Figure 1. W5500 Pin Layout

1.1 Pin Descriptions

Table 1. Pin Type Notation

Type	Description
I	Input
O	Output
I/O	Input / Output
A	Analog
PWR	3.3V power
GND	Ground

Table 2. W5500 Pin Description

Pin No	Symbol	Internal Bias ¹	Type	Description
1	TXN	-	AO	TXP/TXN Signal Pair
2	TXP	-	AO	The differential data is transmitted to the media on the TXP/TXN signal pair.
3	AGND	-	GND	Analog ground
4	AVDD	-	PWR	Analog 3.3V power
5	RXN	-	AI	RXP/RXN Signal Pair
6	RXP	-	AI	The differential data from the media is received on the RXP/RXN signal pair.
7	DNC	-	AI/O	Do Not Connect Pin
8	AVDD	-	PWR	Analog 3.3V power
9	AGND	-	GND	Analog ground
10	EXRES1	-	AI/O	External Reference Resistor It should be connected to an external resistor (12.4KΩ, 1%) needed for biasing of internal analog circuits. Refer to the 'External reference resistor' (Figure.2) for details.
11	AVDD	-	PWR	Analog 3.3V power
12	-	-	-	NC
13	-	-	-	NC
14	AGND	-	GND	Analog ground
15	AVDD	-	PWR	Analog 3.3V power
16	AGND	-	GND	Analog ground
17	AVDD	-	PWR	Analog 3.3V power
18	VBG	-	AO	Band Gap Output Voltage This pin will be measured as 1.2V at 25°C. It must be left floating.
19	AGND	-	GND	Analog ground
20	TOCAP	-	AO	External Reference Capacitor This pin must be connected to a 4.7uF capacitor. The trace length to capacitor should be short to stabilize the internal signals.
21	AVDD	-	PWR	Analog 3.3V power
22	1V2O	-	AO	1.2V Regulator output voltage

¹ Internal Bias after hardware reset

				<p>This pin must be connected to a 10nF capacitor.</p> <p>This is the output voltage of the internal regulator.</p>
23	RSVD	Pull-down	I	It must be tied to GND.
24	SPDLED	-	O	<p>Speed LED</p> <p>This shows the Speed status of the connected link.</p> <p>Low: 100Mbps</p> <p>High: 10Mbps</p>
25	LINKLED	-	O	<p>Link LED</p> <p>This shows the Link status.</p> <p>Low: Link is established</p> <p>High: Link is not established</p>
26	DUPLED	-	O	<p>Duplex LED</p> <p>This shows the Duplex status for the connected link.</p> <p>Low: Full-duplex mode</p> <p>High: Half-duplex mode</p>
27	ACTLED	-	O	<p>Active LED</p> <p>This shows that there is Carrier sense (CRS) from the active Physical Medium Sub-layer (PMD) during TX or RX activity.</p> <p>Low: Carrier sense from the active PMD</p> <p>High: No carrier sense</p>
28	VDD	-	PWR	Digital 3.3V Power
29	GND	-	GND	Digital Ground
30	XI/CLKIN	-	AI	<p>Crystal input / External Clock input</p> <p>External 25MHz Crystal Input.</p> <p>This pin can also be connected to single-ended TTL oscillator (CLKIN). 3.3V clock should be applied for the External Clock input. If this method is implemented, XO should be left unconnected.</p> <p>Refer to the 'Crystal reference schematic' (Figure.3) for details.</p>
31	XO	-	AO	<p>Crystal output</p> <p>External 25MHz Crystal Output</p> <p>Note: Float this pin if using an external clock being driven through XI/CLKIN</p>
32	SCSn	Pull-up	I	<p>Chip Select for SPI bus</p> <p>This pin can be asserted low to select W5500 in SPI interface.</p> <p>Low: selected</p>

				High: deselected																																							
33	SCLK	-	I	SPI clock input This pin is used to receive SPI Clock from SPI master.																																							
34	MISO	-	O	SPI master input slave(W5500) output																																							
35	MOSI	-	I	SPI master output slave(W5500) input																																							
36	INTn	-	O	Interrupt output (Active low) Low: Interrupt asserted from W5500 High: No interrupt																																							
37	RSTn	Pull-up	I	Reset (Active low) RESET should be held low at least 500 us for W5500 reset.																																							
38	RSVD	Pull-down	I	NC																																							
39	RSVD	Pull-down	I	NC																																							
40	RSVD	Pull-down	I	NC																																							
41	RSVD	Pull-down	I	NC																																							
42	RSVD	Pull-down	I	NC																																							
43	PMODE2	Pull-up	I	PHY Operation mode select pins These pins determine the network mode. Refer to the below table for details.																																							
44	PMODE1	Pull-up	I																																								
45	PMODE0	Pull-up	I																																								
				<table border="1"> <thead> <tr> <th colspan="3">PMODE [2:0]</th> <th rowspan="2">Description</th> </tr> <tr> <th>2</th> <th>1</th> <th>0</th> </tr> </thead> <tbody> <tr> <td>0</td> <td>0</td> <td>0</td> <td>10BT Half-duplex, Auto-negotiation disabled</td> </tr> <tr> <td>0</td> <td>0</td> <td>1</td> <td>10BT Full-duplex, Auto-negotiation disabled</td> </tr> <tr> <td>0</td> <td>1</td> <td>0</td> <td>100BT Half-duplex, Auto-negotiation disabled</td> </tr> <tr> <td>0</td> <td>1</td> <td>1</td> <td>100BT Full-duplex, Auto-negotiation disabled</td> </tr> <tr> <td>1</td> <td>0</td> <td>0</td> <td>100BT Half-duplex, Auto-negotiation enabled</td> </tr> <tr> <td>1</td> <td>0</td> <td>1</td> <td>Not used</td> </tr> <tr> <td>1</td> <td>1</td> <td>0</td> <td>Not used</td> </tr> <tr> <td>1</td> <td>1</td> <td>1</td> <td>All capable, Auto-negotiation enabled</td> </tr> </tbody> </table>	PMODE [2:0]			Description	2	1	0	0	0	0	10BT Half-duplex, Auto-negotiation disabled	0	0	1	10BT Full-duplex, Auto-negotiation disabled	0	1	0	100BT Half-duplex, Auto-negotiation disabled	0	1	1	100BT Full-duplex, Auto-negotiation disabled	1	0	0	100BT Half-duplex, Auto-negotiation enabled	1	0	1	Not used	1	1	0	Not used	1	1	1	All capable, Auto-negotiation enabled
PMODE [2:0]			Description																																								
2	1	0																																									
0	0	0	10BT Half-duplex, Auto-negotiation disabled																																								
0	0	1	10BT Full-duplex, Auto-negotiation disabled																																								
0	1	0	100BT Half-duplex, Auto-negotiation disabled																																								
0	1	1	100BT Full-duplex, Auto-negotiation disabled																																								
1	0	0	100BT Half-duplex, Auto-negotiation enabled																																								
1	0	1	Not used																																								
1	1	0	Not used																																								
1	1	1	All capable, Auto-negotiation enabled																																								
46	-	-	-	NC																																							
47	-	-	-	NC																																							
48	AGND	-	GND	Analog ground																																							

The 12.4KΩ(1%) Resistor should be connected between EXRES1 pin and analog ground (AGND) as below.

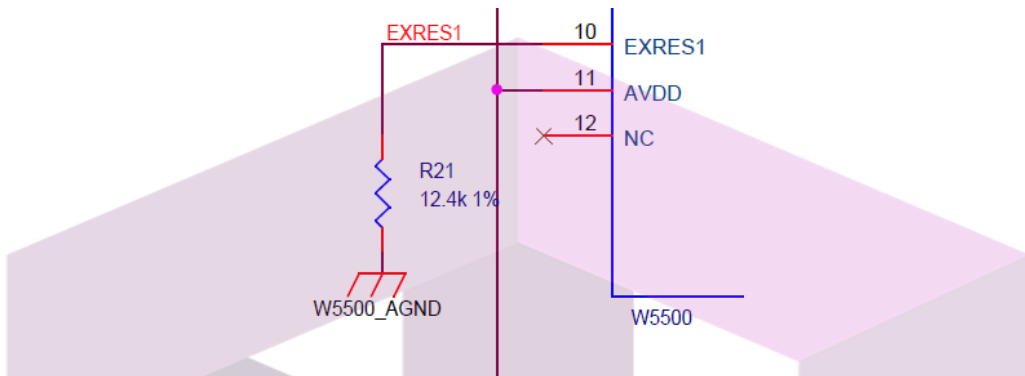

Figure 2. External reference resistor

The crystal reference schematic is shown as below.

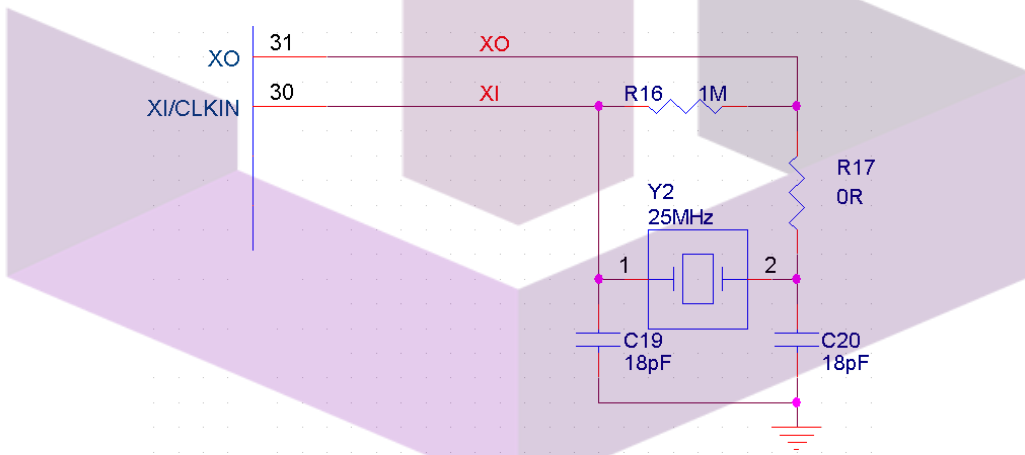

Figure 3. Crystal reference schematic

SKY↑TECH

تهیه و توزیع قطعات الکترونیک

2 HOST Interface

W5500 provides SPI (Serial Peripheral Interface) Bus Interface with 4 signals (SCSn, SCLK, MOSI, MISO) for external HOST interface, and operates as a SPI Slave.

The W5500 SPI can be connected to MCU as shown in Figure 4 and Figure 5 according to its operation mode (Variable Length Data / Fixed Length Data Mode) which will be explained in Chapter 2.3 and Chapter 2.4.

In Figure 4, SPI Bus can be shared with other SPI Devices. Since the SPI Bus is dedicated to W5500, SPI Bus cannot be shared with other SPI Devices. It is shown in Figure 5.

At the Variable Length Data mode (as shown in Figure 4), it is possible to share the SPI Bus with other SPI devices. However, at the Fixed Length Data mode (as shown in Figure 5), the SPI Bus is dedicated to W5500 and can't be shared with other devices.

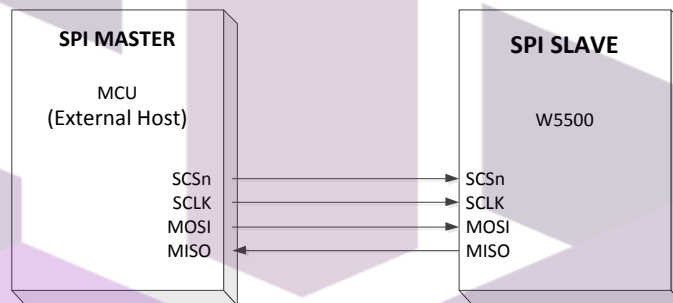

Figure 4. Variable Length Data Mode (SCSn controlled by the host)

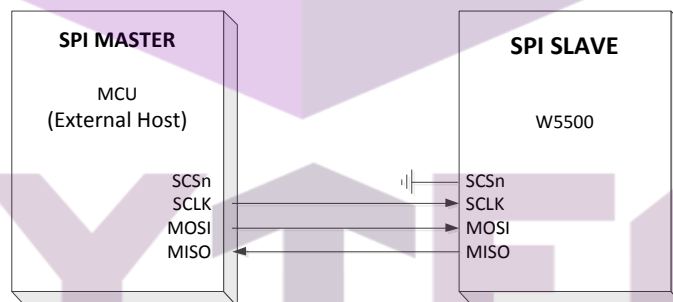

Figure 5. Fixed Length Data Mode (SCSn is always connected by Ground)

The SPI protocol defines four modes for its operation (Mode 0, 1, 2, 3). Each mode differs according to the SCLK polarity and phase. The only difference between SPI Mode 0 and SPI Mode 3 is the polarity of the SCLK signal at the inactive state.

With SPI Mode 0 and 3, data is always latched in on the rising edge of SCLK and always output on the falling edge of SCLK.

The W5500 supports SPI Mode 0 and Mode 3. Both MOSI and MISO signals use transfer sequence from Most Significant Bit (MSB) to Least Significant Bit (LSB) when MOSI signal transmits and MISO signal receives. MOSI & MISO signals always transmit or receive in sequence from the Most Significant Bit (MSB) to Least Significant Bit (LSB).

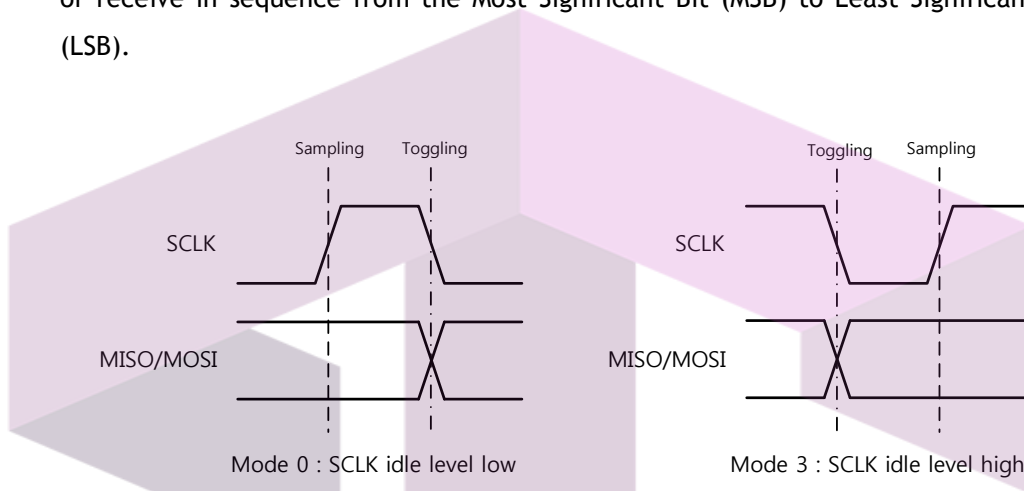

Figure 6. SPI Mode 0 & 3

2.1 SPI Operation Mode

W5500 is controlled by SPI Frame (Refer to the Chapter 2.2 SPI Frame) which communicates with the External Host. W5500 SPI Frame consists 3 phases, Address Phase, Control Phase and Data Phase.

Address Phase specifies 16 bits Offset Address for W5500 Register or TX/RX Memory. Control Phase specifies the block to which Offset (set by Address Phase) belongs, and specifies Read/Write Access Mode and SPI Operation Mode (Variable Length Data / Fixed Length Data Mode).

And Data Phase specifies random length (N-bytes, $1 \leq N$) Data or 1 byte, 2 bytes and 4 bytes Data.

If SPI Operation Mode is set as Variable Length Data Mode (VDM), SPI Bus Signal SCSn must be controlled by the External Host with SPI Frame step.

At the Variable Length Data Mode, SCSn Control Start (Assert (High-to-Low)) informs W5500 of SPI Frame Start (Address Phase), and SCSn Control End (De-assert (Low-to-High)) informs W5500 of SPI Frame End (Data Phase End of random N byte).

2.2 SPI Frame

W5500 SPI Frame consists of 16bits Offset Address in Address Phase, 8bits Control Phase and N bytes Data Phase as shown in Figure 7.

The 8bits Control Phase is reconfigured with Block Select bits (BSB[4:0]), Read/Write Access Mode bit (RWB) and SPI Operation Mode (OM[1:0]).

Block Select bits select the block to which the Offset Address belongs.

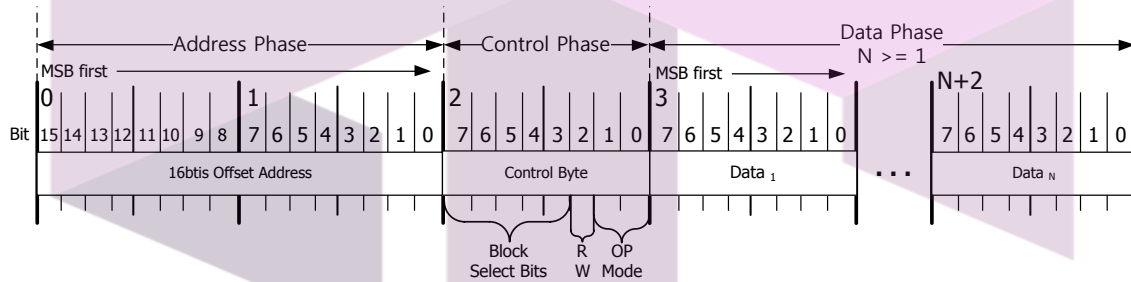

Figure 7. SPI Frame Format

W5500 supports Sequential Data Read/Write. It processes the data from the base (the Offset Address which is set for 2/4/N byte Sequential data processing) and the next data by increasing the Offset Address (auto increment addressing) by 1.

2.2.1 Address Phase

This Address Phase specifies the 16 bits Offset Address for the W5500 Registers and TX/RX Buffer Blocks.

The 16-bit Offset Address value is transferred from MSB to LSB sequentially.

The SPI frame with 2/4/N byte data phase supports the Sequential Data Read/Write in which Offset address automatically increases by 1 every 1 byte data.

2.2.2 Control Phase

The Control Phase specifies the Block to which the Offset Address (set by Address Phase) belongs, the Read/Write Access Mode and the SPI Operation Mode.

7	6	5	4	3	2	1	0
BSB4	BSB3	BSB2	BSB1	BSB0	RWB	OM1	OM0

Bit	Symbol	Description																																														
		<p>Block Select Bits</p> <p>W5500 has Common Register, 8 Socket Register, TX/RX Buffer Block for each Socket.</p> <p>The next table shows the Block selected by BSB[4:0].</p>																																														
7-3	BSB [4:0]	<table border="1"> <thead> <tr> <th style="text-align: center;">BSB [4:0]</th> <th style="text-align: center;">Meaning</th> </tr> </thead> <tbody> <tr><td style="text-align: center;">00000</td><td>Selects Common Register.</td></tr> <tr><td style="text-align: center;">00001</td><td>Selects Socket 0 Register</td></tr> <tr><td style="text-align: center;">00010</td><td>Selects Socket 0 TX Buffer</td></tr> <tr><td style="text-align: center;">00011</td><td>Selects Socket 0 RX Buffer</td></tr> <tr><td style="text-align: center;">00100</td><td>Reserved</td></tr> <tr><td style="text-align: center;">00101</td><td>Selects Socket 1 Register</td></tr> <tr><td style="text-align: center;">00110</td><td>Selects Socket 1 TX Buffer</td></tr> <tr><td style="text-align: center;">00111</td><td>Selects Socket 1 RX Buffer</td></tr> <tr><td style="text-align: center;">01000</td><td>Reserved</td></tr> <tr><td style="text-align: center;">01001</td><td>Selects Socket 2 Register</td></tr> <tr><td style="text-align: center;">01010</td><td>Selects Socket 2 TX Buffer</td></tr> <tr><td style="text-align: center;">01011</td><td>Selects Socket 2 RX Buffer</td></tr> <tr><td style="text-align: center;">01100</td><td>Reserved</td></tr> <tr><td style="text-align: center;">01101</td><td>Selects Socket 3 Register</td></tr> <tr><td style="text-align: center;">01110</td><td>Selects Socket 3 TX Buffer</td></tr> <tr><td style="text-align: center;">01111</td><td>Selects Socket 3 RX Buffer</td></tr> <tr><td style="text-align: center;">10000</td><td>Reserved</td></tr> <tr><td style="text-align: center;">10001</td><td>Selects Socket 4 Register</td></tr> <tr><td style="text-align: center;">10010</td><td>Selects Socket 4 TX Buffer</td></tr> <tr><td style="text-align: center;">10011</td><td>Selects Socket 4 RX Buffer</td></tr> <tr><td style="text-align: center;">10100</td><td>Reserved</td></tr> <tr><td style="text-align: center;">10101</td><td>Selects Socket 5 Register</td></tr> </tbody> </table>	BSB [4:0]	Meaning	00000	Selects Common Register.	00001	Selects Socket 0 Register	00010	Selects Socket 0 TX Buffer	00011	Selects Socket 0 RX Buffer	00100	Reserved	00101	Selects Socket 1 Register	00110	Selects Socket 1 TX Buffer	00111	Selects Socket 1 RX Buffer	01000	Reserved	01001	Selects Socket 2 Register	01010	Selects Socket 2 TX Buffer	01011	Selects Socket 2 RX Buffer	01100	Reserved	01101	Selects Socket 3 Register	01110	Selects Socket 3 TX Buffer	01111	Selects Socket 3 RX Buffer	10000	Reserved	10001	Selects Socket 4 Register	10010	Selects Socket 4 TX Buffer	10011	Selects Socket 4 RX Buffer	10100	Reserved	10101	Selects Socket 5 Register
BSB [4:0]	Meaning																																															
00000	Selects Common Register.																																															
00001	Selects Socket 0 Register																																															
00010	Selects Socket 0 TX Buffer																																															
00011	Selects Socket 0 RX Buffer																																															
00100	Reserved																																															
00101	Selects Socket 1 Register																																															
00110	Selects Socket 1 TX Buffer																																															
00111	Selects Socket 1 RX Buffer																																															
01000	Reserved																																															
01001	Selects Socket 2 Register																																															
01010	Selects Socket 2 TX Buffer																																															
01011	Selects Socket 2 RX Buffer																																															
01100	Reserved																																															
01101	Selects Socket 3 Register																																															
01110	Selects Socket 3 TX Buffer																																															
01111	Selects Socket 3 RX Buffer																																															
10000	Reserved																																															
10001	Selects Socket 4 Register																																															
10010	Selects Socket 4 TX Buffer																																															
10011	Selects Socket 4 RX Buffer																																															
10100	Reserved																																															
10101	Selects Socket 5 Register																																															

		<table border="1"> <tr> <td>10110</td> <td>Selects Socket 5 TX Buffer</td> </tr> <tr> <td>10111</td> <td>Selects Socket 5 RX Buffer</td> </tr> <tr> <td>11000</td> <td>Reserved</td> </tr> <tr> <td>11001</td> <td>Selects Socket 6 Register</td> </tr> <tr> <td>11010</td> <td>Selects Socket 6 TX Buffer</td> </tr> <tr> <td>11011</td> <td>Selects Socket 6 RX Buffer</td> </tr> <tr> <td>11100</td> <td>Reserved</td> </tr> <tr> <td>11101</td> <td>Selects Socket 7 Register</td> </tr> <tr> <td>11110</td> <td>Selects Socket 7 TX Buffer</td> </tr> <tr> <td>11111</td> <td>Selects Socket 7 RX Buffer</td> </tr> </table>	10110	Selects Socket 5 TX Buffer	10111	Selects Socket 5 RX Buffer	11000	Reserved	11001	Selects Socket 6 Register	11010	Selects Socket 6 TX Buffer	11011	Selects Socket 6 RX Buffer	11100	Reserved	11101	Selects Socket 7 Register	11110	Selects Socket 7 TX Buffer	11111	Selects Socket 7 RX Buffer
10110	Selects Socket 5 TX Buffer																					
10111	Selects Socket 5 RX Buffer																					
11000	Reserved																					
11001	Selects Socket 6 Register																					
11010	Selects Socket 6 TX Buffer																					
11011	Selects Socket 6 RX Buffer																					
11100	Reserved																					
11101	Selects Socket 7 Register																					
11110	Selects Socket 7 TX Buffer																					
11111	Selects Socket 7 RX Buffer																					
		If the Reserved Bits are selected, it can cause the mal-function of the W5500.																				
2	RWB	<p>Read/Write Access Mode Bit</p> <p>This sets Read/Write Access Mode.</p> <p>'0' : Read</p> <p>'1' : Write</p>																				
1~0	OM [1:0]	<p>SPI Operation Mode Bits</p> <p>This sets the SPI Operation Mode.</p> <p>SPI Operation Mode supports two modes, the Variable Length Data Mode and the Fixed Length Data Mode.</p> <p>- Variable Length Data Mode (VDM)</p> <p>: Data Length is controlled by SCSn.</p> <p>External Host makes SCSn Signal Assert (High-to-Low) and informs the start of the SPI Frame Address Phase to W5500.</p> <p>Then the external host transfers the Control Phase with OM[1:0]='00'.</p> <p>After N-Bytes Data Phase transfers, SCSn Signal is De-asserted (Low-to-High) and informs the end of the SPI Frame Data Phase to W5500.</p> <p>In VDM Mode, the SCSn must be controlled with SPI Frame unit by the External Host. (Refer to the Figure 4)</p>																				

	<p>- Fixed Length Data Mode (FDM)</p> <p>: In FDM, the Data Length is set by OM[1:0], these are not '00' value. So, the SCSn signal should be Low state, and has one Length type (among 1 Bytes, 2 Bytes, 4 Bytes) according to the OM[1:0] value. (Refer to the Figure 5.)</p> <p>The next table shows the SPI Operation Mode according to the OM[1:0].</p> <table border="1" style="margin-left: auto; margin-right: auto;"> <thead> <tr> <th>OM[1:0]</th> <th>Meaning</th> </tr> </thead> <tbody> <tr> <td>00</td> <td>Variable Data Length Mode, N-Bytes Data Phase ($1 \leq N$)</td> </tr> <tr> <td>01</td> <td>Fixed Data Length Mode , 1 Byte Data Length ($N = 1$)</td> </tr> <tr> <td>10</td> <td>Fixed Data Length Mode , 2 Byte Data Length ($N = 2$)</td> </tr> <tr> <td>11</td> <td>Fixed Data Length Mode , 4 Byte Data Length ($N = 4$)</td> </tr> </tbody> </table>	OM[1:0]	Meaning	00	Variable Data Length Mode, N-Bytes Data Phase ($1 \leq N$)	01	Fixed Data Length Mode , 1 Byte Data Length ($N = 1$)	10	Fixed Data Length Mode , 2 Byte Data Length ($N = 2$)	11	Fixed Data Length Mode , 4 Byte Data Length ($N = 4$)
OM[1:0]	Meaning										
00	Variable Data Length Mode, N-Bytes Data Phase ($1 \leq N$)										
01	Fixed Data Length Mode , 1 Byte Data Length ($N = 1$)										
10	Fixed Data Length Mode , 2 Byte Data Length ($N = 2$)										
11	Fixed Data Length Mode , 4 Byte Data Length ($N = 4$)										

2.2.3 Data Phase

With the Control Phase set by the SPI Operation Mode Bits OM[1:0], the Data Phase is set by two types of length, one type is the N-Bytes length (VDM mode) and the other type is 1/2/4 Bytes (FDM mode).

At this time, 1 byte data is transferred through MOSI or MISO signal from MSB to LSB sequentially.

2.3 Variable Length Data Mode (VDM)

In VDM mode, the SPI Frame Data Phase Length is determined by SCSn Control of the External Host. That means that the Data Phase Length can have random value (Any length from 1 Byte to N Bytes) according to the SCSn Control.

The OM[1:0] of the Control Phase should be '00' value in VDM mode.

2.3.1 Write Access in VDM

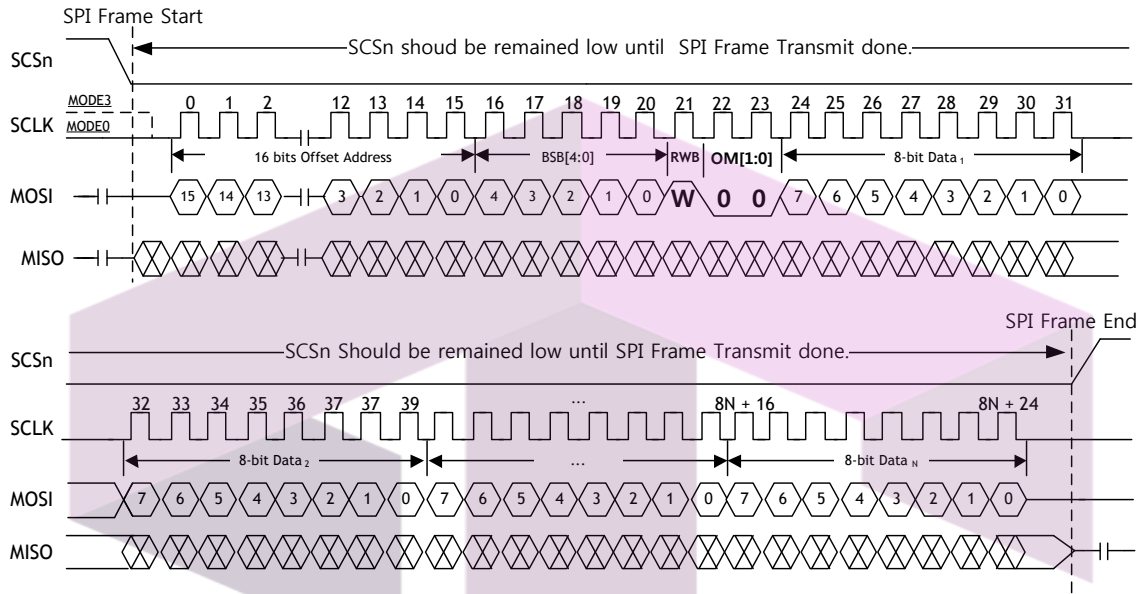

Figure 8. Write SPI Frame in VDM mode

Figure 8 shows the SPI Frame when the external host accesses W5500 for writing. In VDM mode, the RWB signal is '1' (Write), OM[1:0] is '00' in SPI Frame Control Phase.

At this time the External Host asserts (High-to-Low) SCSn signal before transmitting SPI Frame.

Then the Host transmits SPI Frame's all bits to W5500 through MOSI signal. All bits are synchronized with the falling edge of the SCLK.

After finishing the SPI Frame transmit, the Host deasserts SCSn signal (Low-to-High).

When SCSn is Low and the Data Phase continues, the Sequential Data Write can be supported.

SKYTECH

تهیه و توزیع قطعات الکترونیک

1 Byte WRITE Access Example

When the Host writes Data 0xAA to 'Socket Interrupt Mask Register (SIMR) of Common Register Block by using VDM mode, the data is written with the SPI Frame below.

Offset Address	= 0x0018
BSB[4:0]	= '00000'
RWB	= '1'
OM[1:0]	= '00'
1 st Data	= 0xAA

The External Host asserts (High-to-Low) SCSn before transmitting SPI Frame, then the Host transmits 1 bit with synchronizing the Toggle SCLK. The External Host de-asserts (Low-to-High) the SCSn at the end of SPI Frame transmit. (Refer to the Figure 9)

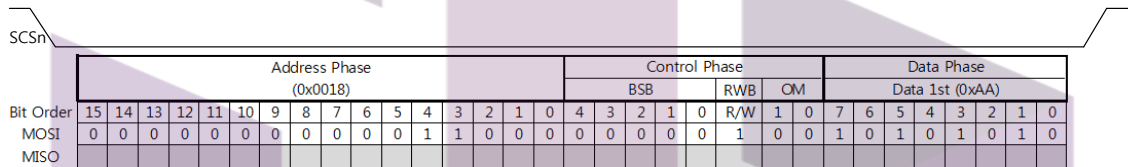

Figure 9. SIMR Register Write in VDM Mode

SKYYTECH

تهیه و توزیع قطعات الکترونیک

N-Bytes WRITE Access Example

When the Host writes 5 Bytes Data (0x11, 0x22, 0x33, 0x44, 0x55) to Socket 1's TX Buffer Block 0x0040 Address by using VDM mode, 5 bytes data are written with the SPI Frame below.

Offset Address	= 0x0040
BSB[4:0]	= '00110'
RWB	= '1'
OM[1:0]	= '00'
1 st Data	= 0x11
2 nd Data	= 0x22
3 rd Data	= 0x33
4 th Data	= 0x44
5 th Data	= 0x55

The N-Bytes Write Access is shown in Figure 10.

The 5 bytes of Data (0x11, 0x22, 0x33, 0x44, 0x55) are written sequentially to Socket 1's Tx Buffer Block Address 0x0040 ~ 0x0044.

The External Host asserts (High-to-Low) SCSn before transmitting SPI Frame.

The External Host de-asserts (Low-to-High) the SCSn at the end of SPI Frame transmit.

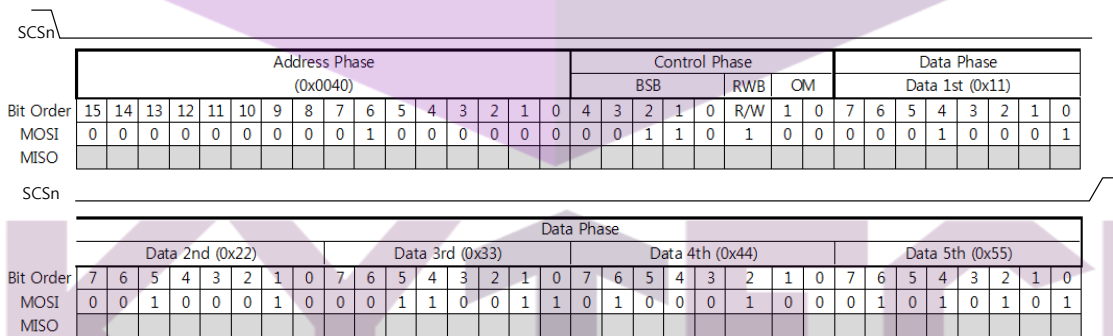

Figure 10. 5 Byte Data Write at 1th Socket's TX Buffer Block 0x0040 in VDM mode

2.3.2 Read Access in VDM

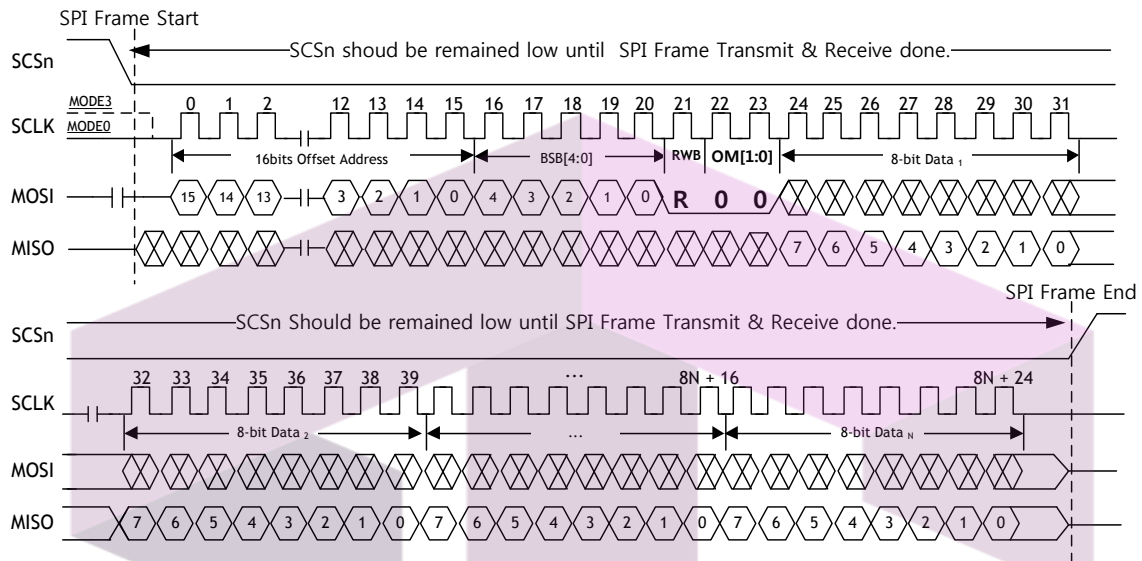

Figure 11. Read SPI Frame in VDM mode

Figure 11 shows the SPI Frame when external host accesses W5500 for reading. In VDM mode, the RWB signal is '0' (Write), OM[1:0] is '00' in SPI Frame Control Phase.

At this time the External Host asserts (High-to-Low) SCSn signal before transmitting SPI Frame.

Then the Host transmits Address and Control Phase all bits to W5500 through MOSI signal. All bits are synchronized with the falling edge of the SCLK.

Then the Host receives all bits of Data Phase with synchronizing the rising edge of Sampling SCLK through MISO signal.

After finishing the Data Phase receive, the Host deasserts SCSn signal (Low-to-High).

When SCSn is Low and the Data Phase continues to receive, the Sequential Data Read can be supported.

SKYYTECH

تهیه و توزیع قطعات الکترونیک

1 Byte READ Access Example

When the Host reads the 'Socket Status Register(S7_SR) of the Socket 7's Register Block by using VDM mode, the data is read with the SPI Frame below. Let's S7_SR to 'SOCK_ESTABLISHED (0x17)'.

Offset Address	= 0x0003
BSB[4:0]	= '11101'
RWB	= '0'
OM[1:0]	= '00'
1 st Data	= 0x17

The External Host asserts (High-to-Low) SCSn signal before transmitting SPI Frame, then the Host transmits Address and Control Phase to W5500 through the MOSI signal.

Then the Host receives Data Phase from the MISO signal.

After finishing the Data Phase receives, the Host deasserts SCSn signal (Low-to-High). (Refer to the Figure 12.)

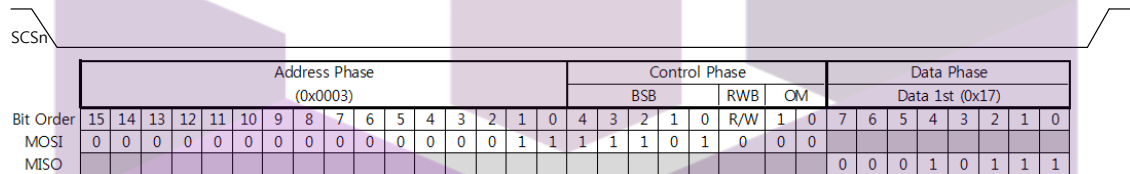

Bit Order	Address Phase (0x0003)																Control Phase						Data Phase									
	15	14	13	12	11	10	9	8	7	6	5	4	3	2	1	0	4	3	2	1	0	R/W	1	0	7	6	5	4	3	2	1	0
MOSI	0	0	0	0	0	0	0	0	0	0	0	0	0	0	1	1	1	1	1	0	1	0	0	0								
MISO																									0	0	0	1	0	1	1	1

Figure 12. S7_SR Read in VDM Mode

SKYYTECH

تهیه و توزیع قطعات الکترونیک

N-Bytes Read Access Example

When the Host reads 5 Bytes Data (0xAA, 0xBB, 0xCC, 0xDD, 0xEE) from the Socket 3's RX Buffer Block 0x0100 Address by using VDM mode, 5 bytes data are read with the SPI Frame as below.

Offset Address	= 0x0100
BSB[4:0]	= '01111'
RWB	= '0'
OM[1:0]	= '00'
1 st Data	= 0xAA
2 nd Data	= 0xBB
3 rd Data	= 0xCC
4 th Data	= 0xDD
5 th Data	= 0xEE

The N-Bytes Read Access is shown in Figure 13.

The 5 bytes of Data (0xAA, 0xBB, 0xCC, 0xDD, 0xEE) are read sequentially from the Socket 3's Rx Buffer Block Address 0x0100 ~ 0x0104.

The External Host asserts (High-to-Low) SCSn before transmitting SPI Frame.

The External Host de-asserts (Low-to-High) the SCSn at the end of the SPI Frame Data Phase.

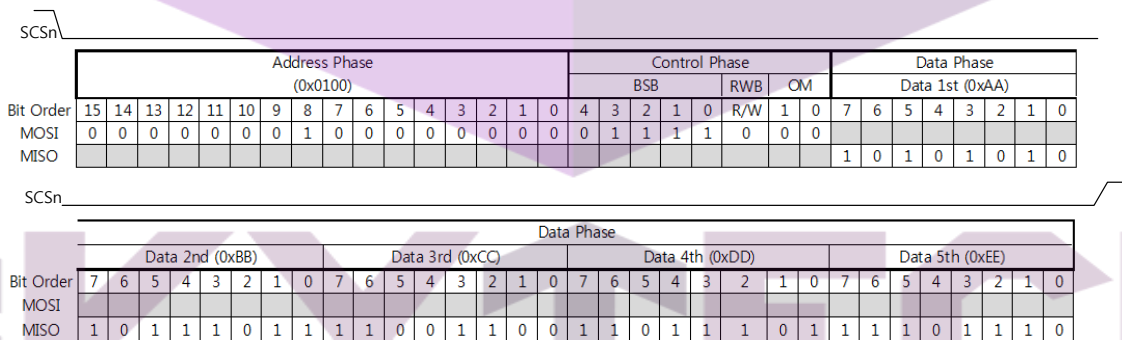

Figure 13. 5 Byte Data Read at Socket 3 RX Buffer Block 0x0100 in VDM mode

2.4 Fixed Length Data Mode (FDM)

The FDM mode can be used when the External Host cannot control SCSn signal.

The SCSn signal should be tied to Low (Always connected to GND) and it is not possible to share the SPI Bus with other SPI Devices. (Refer to the Figure 5.)

In VDM mode, Data Phase length is controlled by SCSn control.

But in FDM mode, Data Phase length is controlled by OM[1:0] value ('01' / '10' / '11') which is the SPI Operation Mode Bits of the Control Phase.

As the SPI Frame of FDM mode is the same as SPI Frame of VDM mode (1Byte, 2 Bytes, 4 Bytes SPI Frame) except for the SCSn signal control and OM[1:0] setting, the detail about FDM mode is not described in this section.

It is not recommended to use the FDM mode unless you are in inevitable status. In addition, we use only 1/2/4 Bytes SPI Frame, as described in 'Chapter 2.4.1' & 'Chapter 2.4.2'. Using SPI Frame with other length of Data will cause malfunction of W5500.



2.4.1 Write Access in FDM

1 Bytes WRITE Access

Bit Order	Address Phase (Any)																Control Phase			Data Phase Data 1st (any)											
	15	14	13	12	11	10	9	8	7	6	5	4	3	2	1	0	4	3	2	1	0	R/W	OM	7	6	5	4	3	2	1	0
MOSI	*	*	*	*	*	*	*	*	*	*	*	*	*	*	*	*	*	*	*	*	*	1	0	1	*	*	*	*	*	*	*
MISO																															

Figure 14. 1 Byte Data Write SPI Frame in FDM mode

2 Bytes WRITE Access

Bit Order	Address Phase (Any)																Control Phase			Data Phase Data 1st (any)											
	15	14	13	12	11	10	9	8	7	6	5	4	3	2	1	0	4	3	2	1	0	R/W	OM	7	6	5	4	3	2	1	0
MOSI	*	*	*	*	*	*	*	*	*	*	*	*	*	*	*	*	*	*	*	*	*	1	1	0	*	*	*	*	*	*	*
MISO																															

Data Phase							
Data 2nd (any)							
Bit Order	7 6 5 4 3 2 1 0						
MOSI	*	*	*	*	*	*	*
MISO							

Figure 15. 2 Bytes Data Write SPI Frame in FDM mode

4 Bytes WRITE Access

Bit Order	Address Phase (Any)																Control Phase			Data Phase Data 1st (any)											
	15	14	13	12	11	10	9	8	7	6	5	4	3	2	1	0	4	3	2	1	0	R/W	OM	7	6	5	4	3	2	1	0
MOSI	*	*	*	*	*	*	*	*	*	*	*	*	*	*	*	*	*	*	*	*	*	1	1	1	*	*	*	*	*	*	*
MISO																															

Data Phase		Data Phase		Data Phase																			
Data 2nd (any)		Data 3rd (any)		Data 4th (any)																			
Bit Order	7 6 5 4 3 2 1 0	7 6 5 4 3 2 1 0	7 6 5 4 3 2 1 0	7 6 5 4 3 2 1 0	7 6 5 4 3 2 1 0																		
MOSI	*	*	*	*	*	*	*	*	*	*	*	*	*	*	*	*	*	*	*	*	*	*	*
MISO																							

Figure 16. 4 Bytes Data Write SPI Frame in FDM mode



2.4.2 Read Access in FDM

1 Byte READ Access

Bit Order	Address Phase (Any)																Control Phase				Data Phase																									
	15	14	13	12	11	10	9	8	7	6	5	4	3	2	1	0	4	3	2	1	0	R/W	OM	Data 1st (Any)																						
MOSI	*	*	*	*	*	*	*	*	*	*	*	*	*	*	*	*	*	*	*	*	*	0	0	1																						
MISO																									*	*	*	*	*	*	*	*	*	*	*	*	*	*	*	*	*	*	*	*	*	*

Figure 17. 1 Byte Data Read SPI Frame in FDM mode

2 Bytes READ Access

Bit Order	Address Phase (Any)																Control Phase				Data Phase																									
	15	14	13	12	11	10	9	8	7	6	5	4	3	2	1	0	4	3	2	1	0	R/W	OM	Data 1st (Any)																						
MOSI	*	*	*	*	*	*	*	*	*	*	*	*	*	*	*	*	*	*	*	*	*	0	1	0																						
MISO																									*	*	*	*	*	*	*	*	*	*	*	*	*	*	*	*	*	*	*	*	*	*

Data Phase	
Data 2nd (Any)	
Bit Order	7 6 5 4 3 2 1 0
MOSI	
MISO	*

Figure 18. 2 Bytes Data Read SPI Frame in FDM mode

4 Bytes READ Access

Bit Order	Address Phase (Any)																Control Phase				Data Phase																									
	15	14	13	12	11	10	9	8	7	6	5	4	3	2	1	0	4	3	2	1	0	R/W	OM	Data 1st (Any)																						
MOSI	*	*	*	*	*	*	*	*	*	*	*	*	*	*	*	*	*	*	*	*	*	0	1	1																						
MISO																									*	*	*	*	*	*	*	*	*	*	*	*	*	*	*	*	*	*	*	*	*	*

Data Phase		Data Phase		Data Phase	
Data 2nd (Any)		Data 3rd (Any)		Data 4th (Any)	
Bit Order	7 6 5 4 3 2 1 0	7 6 5 4 3 2 1 0	7 6 5 4 3 2 1 0	7 6 5 4 3 2 1 0	7 6 5 4 3 2 1 0
MOSI					
MISO	*	*	*	*	*

Figure 19. 4 Bytes Data Read SPI Frame in FDM mode

3 Register and Memory Organization

W5500 has one Common Register Block, eight Socket Register Blocks, and TX/RX Buffer Blocks allocated to each Socket. Each block is selected by the BSB[4:0](Block Select Bit) of SPI Frame. Figure 20 shows the selected block by the BSB[4:0] and the available offset address range of Socket TX/RX Buffer Blocks. Each Socket's TX Buffer Block exists in one 16KB TX memory physically and is initially allocated with 2KB. Also, Each Socket's RX Buffer Block exists in one 16KB RX Memory physically and is initially allocated with 2KB.

Regardless of the allocated size of each Socket TX/RX Buffer, it can be accessible within the 16 bits offset address range (From 0x0000 to 0xFFFF).

Refer to 'Chapter 3.3' for more information about 16KB TX/RX Memory organization and access method.

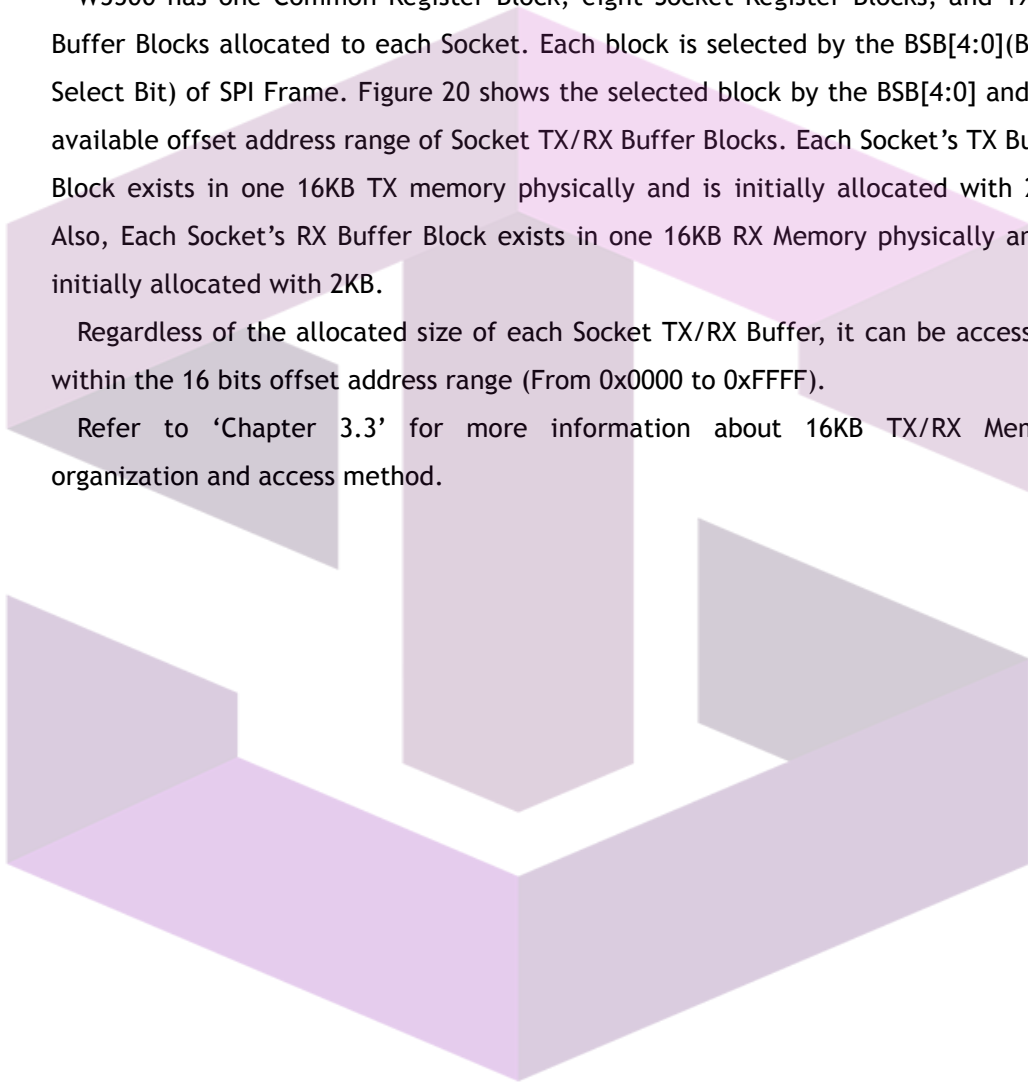

SKYTECH

تهیه و توزیع قطعات الکترونیک

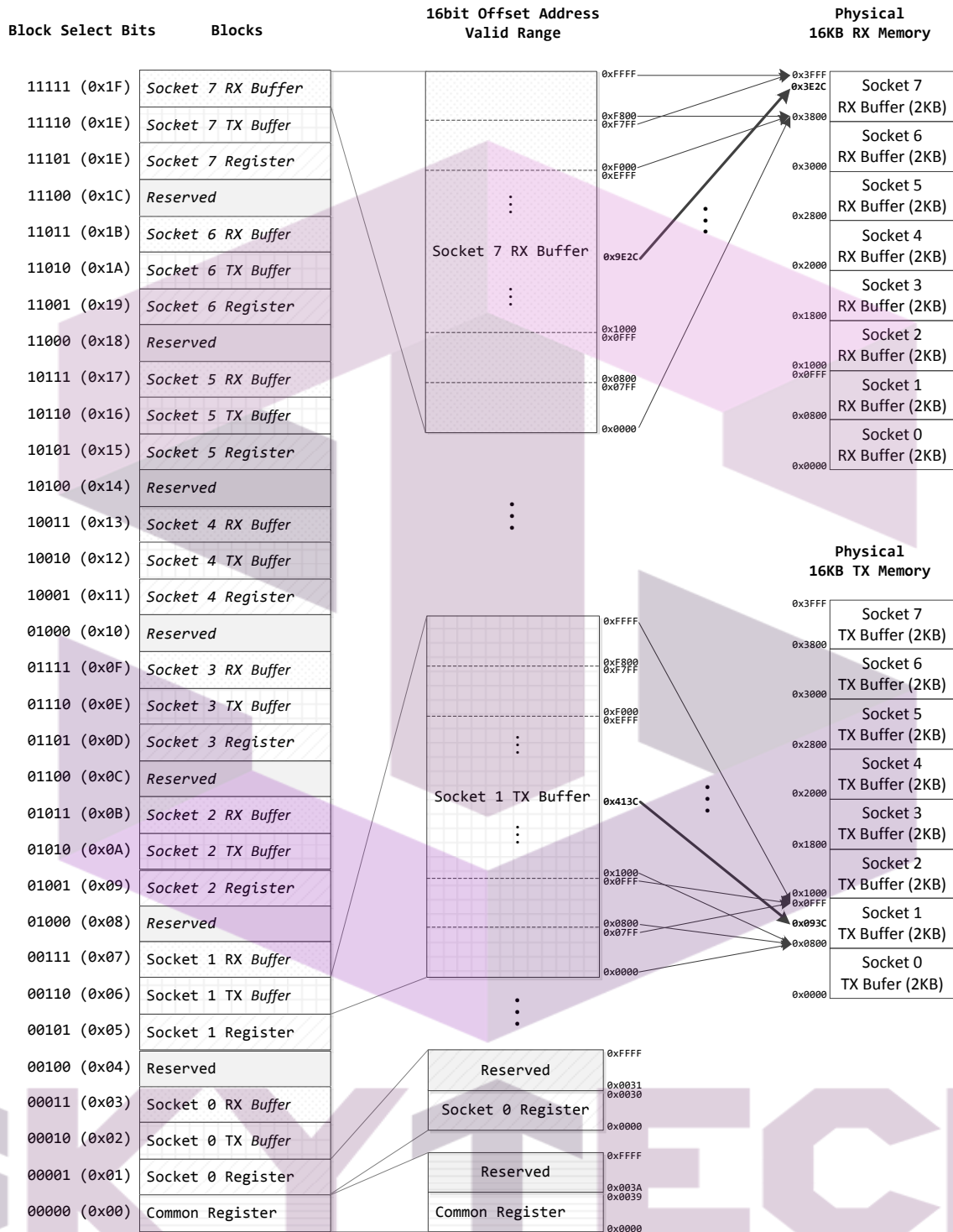

Figure 20. Register & Memory Organization

3.1 Common Register Block

Common Register Block configures the general information of W5500 such as IP and MAC address. This block can be selected by the BSB[4:0] value of SPI Frame. <Table 3> defines the offset address of registers in this block. Refer to ‘Chapter 4.1’ for more details about each register.

Table 3. Offset Address for Common Register

Offset	Register	Offset	Register	Offset	Register
0x0000	Mode (MR)	0x0013	Interrupt Low Level Timer (INTLEVEL0)	0x0021	(PHAR3)
0x0001	Gateway Address (GAR0)	0x0014	(INTLEVEL1)	0x0022	(PHAR4)
0x0002	(GAR1)		Interrupt	0x0023	(PHAR5)
0x0003	(GAR2)	0x0015	(IR)	0x0024	PPP Session Identification (PSID0)
0x0004	(GAR3)		Interrupt Mask	0x0025	(PSID1)
0x0005	Subnet Mask Address (SUBR0)	0x0016	(IMR)	0x0026	PPP Maximum Segment Size (PMRU0)
0x0006	(SUBR1)	0x0017	Socket Interrupt (SIR)	0x0027	(PMRU1)
0x0007	(SUBR2)		Socket Interrupt Mask	0x0028	Unreachable IP address (UIPR0)
0x0008	(SUBR3)	0x0018	(SIMR)	0x0029	(UIPR1)
0x0009	Source Hardware Address (SHAR0)	0x0019	Retry Time (RTR0)	0x002A	(UIPR2)
0x000A	(SHAR1)	0x001A	(RTR1)	0x002B	(UIPR3)
0x000B	(SHAR2)		Retry Count	0x002C	Unreachable Port (UPORTR0)
0x000C	(SHAR3)	0x001B	(RCR)	0x002D	(UPORTR1)
0x000D	(SHAR4)		PPP LCP Request Timer		PHY Configuration
0x000E	(SHAR5)	0x001C	(PTIMER)	0x002E	(PHYCFGR)
0x000F	Source IP Address (SIPR0)		PPP LCP Magic number	0x002F	Reserved
0x0010	(SIPR1)	0x001D	(PMAGIC)	0x0038	Reserved
0x0011	(SIPR2)	0x001E	PPP Destination MAC Address (PHAR0)		Chip version
0x0012	(SIPR3)	0x001F	(PHAR1)	0x0039	(VERSIONR)
0x003A ~ 0xFFFF		0x0020	(PHAR2)		
			Reserved		

3.2 Socket Register Block

W5500 supports 8 Sockets for communication channel. Each Socket is controlled by Socket n Register Block (when $0 \leq n \leq 7$). The n value of Socket n Register can be selected by BSB[4:0] of SPI Frame. <Table 4> defines the 16bits Offset Address of registers in Socket n Register Block.

Refer to 'Chapter 4.2' for more details about each register.

Table 4. Offset Address in Socket n Register Block ($0 \leq n \leq 7$)

Offset	Register	Offset	Register	Offset	Register
0x0000	Socket n Mode (Sn_MR)	0x0010	Socket n Destination Port (Sn_DPORT0)	0x0024	Socket n TX Write Pointer
0x0001	Socket n Command (Sn_CR)	0x0011	(Sn_DPORT1)	0x0025	(Sn_TX_WR0) (Sn_TX_WR1)
0x0002	Socket n Interrupt (Sn_IR)	0x0012	Socket n Maximum Segment Size (Sn_MSSR0)	0x0026	Socket n RX Received Size
0x0003	Socket n Status (Sn_SR)	0x0013	(Sn_MSSR1)	0x0027	(Sn_RX_RSR0) (Sn_RX_RSR1)
0x0004	Socket n Source Port (Sn_PORT0)	0x0014	Reserved	0x0028	Socket n RX Read Pointer
0x0005	(Sn_PORT1)	0x0015	Socket n IP TOS (Sn_TOS)	0x0029	(Sn_RX_RD0) (Sn_RX_RD1)
0x0006	Socket n Destination Hardware Address (Sn_DHAR0)	0x0016	Socket n IP TTL (Sn_TTL)	0x002A	Socket n RX Write Pointer
0x0007	(Sn_DHAR1)	0x0017	Reserved	0x002B	(Sn_RX_WR0) (Sn_RX_WR1)
0x0008	(Sn_DHAR2)	0x001D	Reserved	0x002C	Socket n Interrupt Mask (Sn_IMR)
0x0009	(Sn_DHAR3)	0x001E	Socket n Receive Buffer Size (Sn_RXBUF_SIZE)	0x002D	Socket n Fragment Offset in IP header (Sn_FRAG0)
0x000A	(Sn_DHAR4)	0x001F	Socket n Transmit Buffer Size (Sn_TXBUF_SIZE)	0x002E	(Sn_FRAG1)
0x000B	(Sn_DHAR5)	0x0020	Socket n TX Free Size (Sn_TX_FSR0)	0x002F	Keep alive timer (Sn_KPALVTR)
0x000C	Socket n Destination IP Address (Sn_DIPR0)	0x0021	(Sn_TX_FSR1)	0x0030	Reserved
0x000D	(Sn_DIPR1)	0x0022	Socket n TX Read Pointer (Sn_TX_RD0)	~	
0x000E	(Sn_DIPR2)	0x0023	(Sn_TX_RD1)	0xFFFF	
0x000F	(Sn_DIPR3)				

3.3 Memory

W5500 has one 16KB TX memory for Socket n TX Buffer Blocks and one 16KB RX memory for Socket n RX buffer Blocks.

16KB TX memory is initially allocated in 2KB size for each Socket TX Buffer Block (2KB X 8 = 16KB). The initial allocated 2KB size of Socket n TX Buffer can be re-allocated by using 'Socket n TX Buffer Size Register (Sn_TXBUF_SIZE)'.

Once all Sn_TXBUF_SIZE registers have been configured, Socket TX Buffer is allocated with the configured size of 16KB TX Memory and is assigned sequentially from Socket 0 to Socket 7. Its physical memory address is automatically determined in 16KB TX memory. Therefore, the total sum of Sn_TXBUF_SIZE should be not exceed 16 in case of error in data transmission.

The 16KB RX memory allocation method is the same as the 16KB TX memory allocation method. 16KB RX memory is initially allocated into 2KB size for each Socket RX Buffer Block (2KB X 8 = 16KB). The initial allocated 2KB size of Socket n RX Buffer can be re-allocated by using 'Socket n RX Buffer Size Register (Sn_RXBUF_SIZE)'.

When all Sn_RXBUF_SIZE registers have been configured, the Socket RX Buffer is allocated with the configured size in 16KB RX Memory and is assigned sequentially from Socket 0 to Socket 7. The physical memory address of the Socket RX Buffer is automatically determined in 16KB RX memory. Therefore, the total sum of Sn_RXBUF_SIZE should not exceed 16, data reception error will occur if exceeded.

For 16KB TX/RX memory allocation, refer to Sn_TXBUF_SIZE & Sn_RXBUF_SIZE in 'Chapter 4.2'.

The Socket n TX Buffer Block allocated in 16KB TX memory is buffer for saving data to be transmitted by host. The 16bits Offset Address of Socket n TX Buffer Block has 64KB address space ranged from 0x0000 to 0xFFFF, and it is configured with reference to 'Socket n TX Write Pointer Register (Sn_TX_WR)' & 'Socket n TX Read Pointer Register(Sn_TX_RD)'. However, the 16bits Offset Address automatically converts into the physical address to be accessible in 16KB TX memory such as Figure 20. Refer to 'Chapter 4.2' for Sn_TX_WR & Sn_TX_RD.

The Socket n RX Buffer Block allocated in 16KB RX memory is buffer for saving the received data through the Ethernet. The 16bits Offset Address of Socket n RX Buffer Block has 64KB address space ranged from 0x0000 to 0xFFFF, and it is configured with reference to 'Socket n RX RD Pointer Register (Sn_RX_RD)' & 'Socket n RX Write Pointer Register (Sn_RX_WR)'. However, the 16bits Offset Address automatically converts into the physical address to be accessible in 16KB RX memory such as Figure 20. Refer to 'Chapter 4.2' for Sn_RX_RD & Sn_RX_WR.

4 Register Descriptions

4.1 Common Registers

MR (Mode Register) [R/W] [0x0000] [0x00]²

MR is used for S/W reset, ping block mode and PPPoE mode.

7	6	5	4	3	2	1	0
RST	Reserved	WOL	PB	PPPoE	Reserved	FARP	Reserved

Bit	Symbol	Description
7	RST	If this bit is '1', All internal registers will be initialized. It will be automatically cleared as '0' after S/W reset.
6	Reserved	Reserved
5	WOL	<p>Wake on LAN</p> <p>0 : Disable WOL mode 1 : Enable WOL mode</p> <p>If WOL mode is enabled and the received magic packet over UDP has been normally processed, the Interrupt PIN (INTn) asserts to low. When using WOL mode, the UDP Socket should be opened with any source port number. (Refer to Socket n Mode Register (Sn_MR) for opening Socket.)</p> <p>Notice: The magic packet over UDP supported by W5500 consists of 6 bytes synchronization stream ('0xFFFFFFFF') and 16 times Target MAC address stream in UDP payload. The options such like password are ignored. You can use any UDP source port number for WOL mode.</p>
4	PB	<p>Ping Block Mode</p> <p>0 : Disable Ping block 1 : Enable Ping block</p> <p>If the bit is '1', it blocks the response to a ping request.</p>
3	PPPoE	<p>PPPoE Mode</p> <p>0 : Disable PPPoE mode 1 : Enable PPPoE mode</p> <p>If you use ADSL, this bit should be '1'.</p>
2	Reserved	Reserved
1	FARP	Force ARP

² Register Notation : [Read/Write] [Address] [Reset value]

		0 : Disable Force ARP mode 1 : Enable Force ARP mode In Force ARP mode, It forces on sending ARP Request whenever data is sent.
0	Reserved	Reserved

GAR (Gateway IP Address Register) [R/W] [0x0001 - 0x0004] [0x00]

GAR configures the default gateway address.

Ex) In case of "192.168.0.1"

0x0001	0x0002	0x0003	0x0004
192 (0xC0)	168 (0xA8)	0 (0x00)	1 (0x01)

SUBR (Subnet Mask Register) [R/W] [0x0005 - 0x0008] [0x00]

SUBR configures the subnet mask address.

Ex) In case of "255.255.255.0"

0x0005	0x0006	0x0007	0x0008
255 (0xFF)	255 (0xFF)	255 (0xFF)	0 (0x00)

SHAR (Source Hardware Address Register) [R/W] [0x0009 - 0x000E] [0x00]

SHAR configures the source hardware address.

Ex) In case of "00.08.DC.01.02.03"

0x0009	0x000A	0x000B	0x000C	0x000D	0x000E
0x00	0x08	0xDC	0x01	0x02	0x03

SIPR (Source IP Address Register) [R/W] [0x000F - 0x0012] [0x00]

SIPR configures the source IP address.

Ex) In case of "192.168.0.2"

0x000F	0x0010	0x0011	0x0012
192 (0xC0)	168 (0xA8)	0 (0x00)	2 (0x02)

INTLEVEL (Interrupt Low Level Timer Register) [R/W] [0x0013 - 0x0014] [0x0000]

INTLEVEL configures the Interrupt Assert Wait Time (I_{AWT}). When the next interrupt occurs, Interrupt PIN ($INTn$) will assert to low after INTLEVEL time.

$$I_{AWT} = (INTLEVEL + 1) \times PLL_{CLK} \times 4 \text{ (when } INTLEVEL > 0)$$

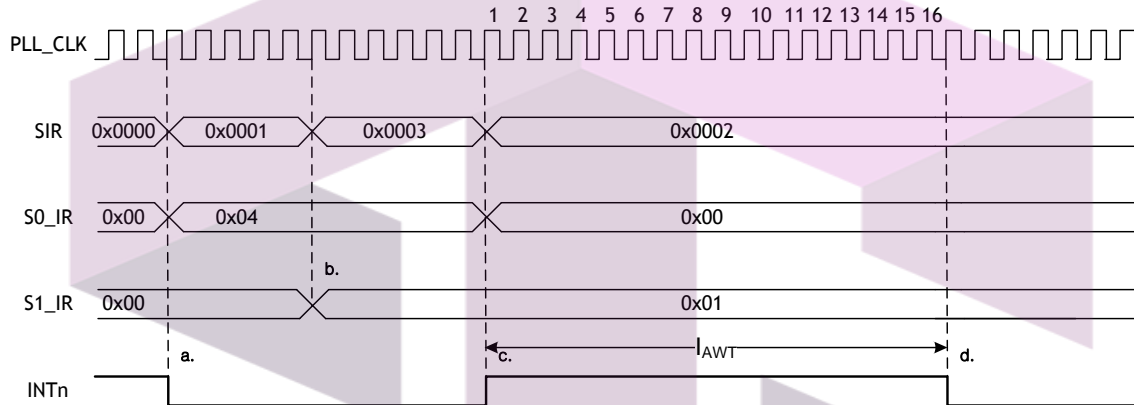

Figure 21. INTLEVEL Timing

- When Timeout Interrupt of Socket 0 is occurred, S0_IR[3] & SIR[0] bit set as '1' and then INTn PIN is asserted to low.
- When the connection interrupt of Socket 1 is occurred before the previous interrupt processing is not completed, S1_IR[0] & SIR[1] bits set as '1' and INTn PIN is still low.
- If the host processed the previous interrupt completely by clearing the S0_IR[3] bit, INTn PIN is de-asserted to high but S1_IR[0] & SIR[1] is still set as '1'.
- Although S1_IR[0] & SIR[1] bit is set as '1', the INTn can't be asserted to low during INTLEVEL time. After the INTLEVEL time expires, the INTn will be asserted to low.

SKYTECH

تهیه و توزیع قطعات الکترونیک

IR (Interrupt Register) [R/W] [0x0015] [0x00]

IR indicates the interrupt status. Each bit of IR can be cleared when the host writes '1' value to each bit. If IR is not equal to '0x00', INTn PIN is asserted low until it is '0x00'.

7	6	5	4	3	2	1	0
CONFLICT	UNREACH	PPPoE	MP	Reserved	Reserved	Reserved	Reserved

Bit	Symbol	Description
7	CONFLICT	IP Conflict Bit is set as '1' when own source IP address is same with the sender IP address in the received ARP request.
6	UNREACH	Destination unreachable When receiving the ICMP (Destination port unreachable) packet, this bit is set as '1'. When this bit is '1', Destination Information such as IP address and Port number may be checked with the corresponding UIPR & UPORTR.
5	PPPoE	PPPoE Connection Close When PPPoE is disconnected during PPPoE mode, this bit is set.
4	MP	Magic Packet When WOL mode is enabled and receives the magic packet over UDP, this bit is set.
3-0	Reserved	Reserved

SKYTECH

تهیه و توزیع قطعات الکترونیک

IMR (Interrupt Mask Register) [R/W][0x0016][0x00]

IMR is used to mask interrupts. Each bit of IMR corresponds to each bit of IR. When a bit of IMR is '1' and the corresponding bit of IR is '1', an interrupt will be issued. In other words, if a bit of IMR is '0', an interrupt will not be issued even if the corresponding bit of IR is '1'.

7	6	5	4	3	2	1	0
IM_IR7	IM_IR6	IM_IR5	IM_IR4	Reserved	Reserved	Reserved	Reserved

Bit	Symbol	Description
7	IM_IR7	IP Conflict Interrupt Mask 0: Disable IP Conflict Interrupt 1: Enable IP Conflict Interrupt
6	IM_IR6	Destination unreachable Interrupt Mask 0: Disable Destination unreachable Interrupt 1: Enable Destination unreachable Interrupt
5	IM_IR5	PPPoE Close Interrupt Mask 0: Disable PPPoE Close Interrupt 1: Enable PPPoE Close Interrupt
4	IM_IR4	Magic Packet Interrupt Mask 0: Disable Magic Packet Interrupt 1: Enable Magic Packet Interrupt
3-0	Reserved	Reserved

SKYTECH

تهیه و توزیع قطعات الکترونیک

SIR (Socket Interrupt Register) [R/W] [0x0017] [0x00]

SIR indicates the interrupt status of Socket. Each bit of SIR be still '1' until Sn_IR is cleared by the host. If Sn_IR is not equal to '0x00', the n-th bit of SIR is '1' and INTn PIN is asserted until SIR is '0x00'.

7	6	5	4	3	2	1	0
S7_INT	S6_INT	S5_INT	S4_INT	S3_INT	S2_INT	S1_INT	S0_INT

Bit	Symbol	Description
7 ~ 0	Sn_INT	When the interrupt of Socket n occurs, the n-th bit of SIR becomes '1'.

SIMR (Socket Interrupt Mask Register) [R/W] [0x0018] [0x00]

Each bit of SIMR corresponds to each bit of SIR. When a bit of SIMR is '1' and the corresponding bit of SIR is '1', Interrupt will be issued. In other words, if a bit of SIMR is '0', an interrupt will be not issued even if the corresponding bit of SIR is '1'.

7	6	5	4	3	2	1	0
S7_IMR	S6_IMR	S5_IMR	S4_IMR	S3_IMR	S2_IMR	S1_IMR	S0_IMR

Bit	Symbol	Description
7 ~ 0	Sn_IMR	Socket n(Sn_INT) Interrupt Mask 0: Disable Socket n Interrupt 1: Enable Socket n Interrupt

SKYTECH

تهیه و توزیع قطعات الکترونیک

RTR (Retry Time-value Register) [R/W] [0x0019 - 0x001A] [0x07D0]

RTR configures the retransmission timeout period. The unit of timeout period is 100us and the default of RTR is '0x07D0' or '2000'. And so the default timeout period is 200ms(100us X 2000).

During the time configured by RTR, W5500 waits for the peer response to the packet that is transmitted by Sn_CR(CONNECT, DISCON, CLOSE, SEND, SEND_MAC, SEND_KEEP command). If the peer does not respond within the RTR time, W5500 retransmits the packet or issues timeout.

Ex) When timeout-period is set as 400ms, $RTR = (400ms / 1ms) \times 10 = 4000(0x0FA0)$

0x0019	0x001A
0x0F	0xA0

RCR (Retry Count Register) [R/W] [0x001B] [0x08]

RCR configures the number of time of retransmission. When retransmission occurs as many as 'RCR+1', Timeout interrupt is issued (Sn_IR[TIMEOUT] = '1').

Ex) RCR = 0x0007

0x001B
0x07

The timeout of W5500 can be configurable with RTR and RCR. W5500 has two kind timeout such as Address Resolution Protocol (ARP) and TCP retransmission.

At the ARP (Refer to RFC 826, <http://www.ietf.org/rfc.html>) retransmission timeout, W5500 automatically sends ARP-request to the peer's IP address in order to acquire MAC address information (used for communication of IP, UDP, or TCP). While waiting for ARP-response from the peer, if there is no response during the configured RTR time, a temporary timeout is occurred and ARP-request is retransmitted. It is repeated as many as 'RCR + 1' times. Even after the ARP-request retransmissions are repeated as 'RCR+1' and there is no response to the ARP-request, the final timeout is occurred and Sn_IR(TIMEOUT) becomes '1'. The time of final timeout (ARP_{T0}) of ARP-request is as below.

$$ARP_{T0} = (RTR \times 0.1ms) \times (RCR + 1)$$

At the TCP packet retransmission timeout, W5500 transmits TCP packets (SYN, FIN, RST, DATA packets) and waits for the acknowledgement (ACK) during the configured RTR time and RCR. If there is no ACK from the peer, a temporary timeout occurs and

the TCP packet is retransmitted. The retransmission is repeated as many as 'RCR+1'. Even after TCP retransmission is repeated as 'RCR+1' and there is no response to the TCP retransmission, the final timeout is occurred and Sn_IR(TIMEOUT) becomes '1'. The time of final timeout (TCPTO) of TCP retransmission is as below.

$$TCP_{TO} = \left(\sum_{N=0}^M (RTR \times 2^N) + ((RCR - M) \times RTR_{MAX}) \right) \times 0.1ms$$

N : Retransmission count, $0 \leq N \leq M$
M : Minimum value when $RTR \times 2^{(M+1)} > 65535$ and $0 \leq M \leq RCR$
RTRMAX : $RTR \times 2^M$

Ex) When RTR = 2000(0x07D0), RCR = 8(0x0008),

$$ARP_{TO} = 2000 \times 0.1ms \times 9 = 1800ms = 1.8s$$

$$TCP_{TO} = (0x07D0+0x0FA0+0x1F40+0x3E80+0x7D00+0xFA00+0xFA00+0xFA00+0xFA00) \times 0.1ms$$

$$= (2000 + 4000 + 8000 + 16000 + 32000 + ((8 - 4) \times 64000)) \times 0.1ms$$

$$= 318000 \times 0.1ms = 31.8s$$

PTIMER (PPP Link Control Protocol Request Timer Register) [R/W] [0x001C] [0x0028]

PTIMER configures the time for sending LCP echo request. The unit of time is 25ms.

Ex) in case that PTIMER is 200,

$$200 * 25(ms) = 5000(ms) = 5 \text{ seconds}$$

PMAGIC (PPP Link Control Protocol Magic number Register) [R/W] [0x001D] [0x00]

PMAGIC configures the 4bytes magic number to be used in LCP echo request.

Ex) PMAGIC = 0x01

0x001D

0x01

LCP Magic number = 0x01010101

PHAR (Destination Hardware Address Register in PPPoE mode)

[R/W] [0x001E-0x0023] [0x0000]

PHAR should be written to the PPPoE server hardware address acquired in PPPoE connection process

Ex) In case that destination hardware address is 00:08:DC:12:34:56

0x001E	0x001F	0x0020	0x0021	0x0022	0x0023
0x00	0x08	0xDC	0x12	0x34	0x56

PSID (Session ID Register in PPPoE mode) [R/W] [0x0024-0x0025] [0x0000]

PSID should be written to the PPPoE sever session ID acquired in PPPoE connection process.

Ex) In case that Session ID is 0x1234

0x0024	0025
18 (0x12)	52(0x34)

PMRU (Maximum Receive Unit in PPPoE mode) [R/W] [0x0026-0x0027] [0xFFFF]

PMRU configures the maximum receive unit of PPPoE.

Ex) in case that maximum receive unit in PPPoE is 0x1234

0x0026	0027
18 (0x12)	52 (0x34)

SKY↑TECH

تهیه و توزیع قطعات الکترونیک

UIPR (Unreachable IP Address Register) [R] [0x0028-0x002B] [0x00000000]

UPORTR (Unreachable Port Register) [R] [0x002C-0x002D] [0x0000]

W5500 receives an ICMP packet(Destination port unreachable) when data is sent to a port number which socket is not open and UNREACH bit of IR becomes '1' and UIPR & UPORTR indicates the destination IP address & port number respectively.

Ex) In case of "192.168.0.11"

0x0028	0x0029	0x002A	0x002B
192 (0xC0)	168 (0xA8)	0 (0x00)	11 (0x0E)

Ex) In case of "0x1234"

0x002C	002D
18 (0x12)	52(0x34)

SKYYTECH

تهیه و توزیع قطعات الکترونیک

PHYCFGR (W5500 PHY Configuration Register) [R/W] [0x002E] [0b10111XXX]

PHYCFGR configures PHY operation mode and resets PHY. In addition, PHYCFGR indicates the status of PHY such as duplex, Speed, Link.

Bit	Symbol	Description																																				
7	RST	<p>Reset [R/W]</p> <p>When this bit is '0', internal PHY is reset. After PHY reset, it should be set as '1'.</p>																																				
6	OPMD	<p>Configure PHY Operation Mode</p> <p>1: Configure with OPMD[2:0] in PHYCFGR 0: Configure with the H/W PINs(PMODE[2:0])</p> <p>This bit configures PHY operation mode with OPMD[2:0] bits or PMODE[2:0] PINs. When W5500 is reset by POR or RSTn PIN, PHY operation mode is configured with PMODE[2:0] PINs by default. After POR or RSTn reset, user can re-configure PHY operation mode with OPMD[2:0]. If user wants to re-configure with PMDC[2:0], it should reset PHY by setting the RST bit to '0' after the user configures this bit as '1' and OPMD[2:0] .</p>																																				
5-3	OPMDC	<p>Operation Mode Configuration Bit[R/W]</p> <p>These bits select the operation mode of PHY such as following table.</p> <table border="1"> <thead> <tr> <th>5</th> <th>4</th> <th>3</th> <th>Description</th> </tr> </thead> <tbody> <tr> <td>0</td> <td>0</td> <td>0</td> <td>10BT Half-duplex, Auto-negotiation disabled</td> </tr> <tr> <td>0</td> <td>0</td> <td>1</td> <td>10BT Full-duplex, Auto-negotiation disabled</td> </tr> <tr> <td>0</td> <td>1</td> <td>0</td> <td>100BT Half-duplex, Auto-negotiation disabled</td> </tr> <tr> <td>0</td> <td>1</td> <td>1</td> <td>100BT Full-duplex, Auto-negotiation disabled</td> </tr> <tr> <td>1</td> <td>0</td> <td>0</td> <td>100BT Half-duplex, Auto-negotiation enabled</td> </tr> <tr> <td>1</td> <td>0</td> <td>1</td> <td>Not used</td> </tr> <tr> <td>1</td> <td>1</td> <td>0</td> <td>Power Down mode</td> </tr> <tr> <td>1</td> <td>1</td> <td>1</td> <td>All capable, Auto-negotiation enabled</td> </tr> </tbody> </table>	5	4	3	Description	0	0	0	10BT Half-duplex, Auto-negotiation disabled	0	0	1	10BT Full-duplex, Auto-negotiation disabled	0	1	0	100BT Half-duplex, Auto-negotiation disabled	0	1	1	100BT Full-duplex, Auto-negotiation disabled	1	0	0	100BT Half-duplex, Auto-negotiation enabled	1	0	1	Not used	1	1	0	Power Down mode	1	1	1	All capable, Auto-negotiation enabled
5	4	3	Description																																			
0	0	0	10BT Half-duplex, Auto-negotiation disabled																																			
0	0	1	10BT Full-duplex, Auto-negotiation disabled																																			
0	1	0	100BT Half-duplex, Auto-negotiation disabled																																			
0	1	1	100BT Full-duplex, Auto-negotiation disabled																																			
1	0	0	100BT Half-duplex, Auto-negotiation enabled																																			
1	0	1	Not used																																			
1	1	0	Power Down mode																																			
1	1	1	All capable, Auto-negotiation enabled																																			
2	DPX	<p>Duplex Status [Read Only]</p> <p>1: Full duplex 0: Half duplex</p>																																				
1	SPD	<p>Speed Status [Read Only]</p> <p>1: 100Mbps based 0: 10Mbps based</p>																																				
0	LNK	<p>Link Status [Read Only]</p> <p>1: Link up 0: Link down</p>																																				

VERSIONR (W5500 Chip Version Register) [R] [0x0039] [0x04]

VERSIONR always indicates the W5500 version as 0x04.



SKYYTECH

تهیه و توزیع قطعات الکترونیک

4.2 Socket Registers

Sn³_MR (Socket n Mode Register) [R/W] [0x0000] [0x00]

Sn_MR configures the option or protocol type of Socket n.

7	6	5	4	3	2	1	0
MULTI/ MFEN	BCASTB	ND / MC /MMB	UCASTB MIP6B	P3	P2	P1	P0

Bit	Symbol	Description
7	MULTI/ MFEN	<p>Multicasting in UDP mode 0 : disable Multicasting 1 : enable Multicasting This bit is applied only during UDP mode(P[3:0] = '0010'). To use multicasting, Sn_DIPR & Sn_DPORT should be respectively configured with the multicast group IP address & port number before Socket n is opened by OPEN command of Sn_CR</p> <p>MAC Filter Enable in MACRAW mode 0 : disable MAC Filtering 1 : enable MAC Filtering This bit is applied only during MACRAW mode(P[3:0] = '0100'). When set as '1', W5500 can only receive broadcasting packet or packet sent to itself. When this bit is '0', W5500 can receive all packets on Ethernet. If user wants to implement Hybrid TCP/IP stack, it is recommended that this bit is set as '1' for reducing host overhead to process the all received packets.</p>
6	BCASTB	<p>Broadcast Blocking in MACRAW and UDP mode 0 : disable Broadcast Blocking 1 : enable Broadcast Blocking This bit blocks to receive broadcasting packet during UDP mode(P[3:0] = '0010'). In addition, This bit does when MACRAW mode(P[3:0] = '0100')</p>
5	ND/MC/ MMB	<p>Use No Delayed ACK 0 : Disable No Delayed ACK option 1 : Enable No Delayed ACK option This bit is applied only during TCP mode (P[3:0] = '0001'). When this bit is '1', It sends the ACK packet without delay as soon as a</p>

³n is Socket number (0, 1, 2, 3, 4, 5, 6, 7). n is set 'SNUM[2:0]' in Control Bits sets.

		<p>Data packet is received from a peer. When this bit is '0', It sends the ACK packet after waiting for the timeout time configured by RTR.</p> <p>Multicast 0 : using IGMP version 2 1 : using IGMP version 1 This bit is applied only during UDP mode(P[3:0] = '0010') and MULTI = '1'. It configures the version for IGMP messages (Join/Leave/Report).</p> <p>Multicast Blocking in MACRAW mode 0 : disable Multicast Blocking 1 : enable Multicast Blocking This bit is applied only when MACRAW mode(P[3:0] = '0100'). It blocks to receive the packet with multicast MAC address.</p>																									
4	UCASTB MIP6B	<p>UNICAST Blocking in UDP mode 0 : disable Unicast Blocking 1 : enable Unicast Blocking This bit blocks receiving the unicast packet during UDP mode(P[3:0] = '0010') and MULTI = '1'.</p> <p>IPv6 packet Blocking in MACRAW mode 0 : disable IPv6 Blocking 1 : enable IPv6 Blocking This bit is applied only during MACRAW mode (P[3:0] = '0100'). It blocks to receiving the IPv6 packet.</p>																									
3	P3	<p>Protocol This configures the protocol mode of Socket n.</p> <table border="1" data-bbox="598 1579 1284 1825"> <thead> <tr> <th>P3</th> <th>P2</th> <th>P1</th> <th>P0</th> <th>Meaning</th> </tr> </thead> <tbody> <tr> <td>0</td> <td>0</td> <td>0</td> <td>0</td> <td>Closed</td> </tr> <tr> <td>0</td> <td>0</td> <td>0</td> <td>1</td> <td>TCP</td> </tr> <tr> <td>0</td> <td>0</td> <td>1</td> <td>0</td> <td>UDP</td> </tr> <tr> <td>0</td> <td>1</td> <td>0</td> <td>0</td> <td>MACRAW</td> </tr> </tbody> </table> <p>* MACRAW mode should be only used in Socket 0.</p>	P3	P2	P1	P0	Meaning	0	0	0	0	Closed	0	0	0	1	TCP	0	0	1	0	UDP	0	1	0	0	MACRAW
P3	P2		P1	P0	Meaning																						
0	0		0	0	Closed																						
0	0		0	1	TCP																						
0	0	1	0	UDP																							
0	1	0	0	MACRAW																							
2	P2																										
1	P1																										
0	P0																										

Sn_CR (Socket n Command Register) [R/W] [0x0001] [0x00]

This is used to set the command for Socket n such as OPEN, CLOSE, CONNECT, LISTEN, SEND, and RECEIVE. After W5500 accepts the command, the Sn_CR register is automatically cleared to 0x00. Even though Sn_CR is cleared to 0x00, the command is still being processed. To check whether the command is completed or not, please check the Sn_IR or Sn_SR.

Value	Symbol	Description										
0x01	OPEN	<p>Socket n is initialized and opened according to the protocol selected in Sn_MR (P3:P0). The table below shows the value of Sn_SR corresponding to Sn_MR.</p> <table border="1"> <thead> <tr> <th>Sn_MR (P[3:0])</th> <th>Sn_SR</th> </tr> </thead> <tbody> <tr> <td>Sn_MR_CLOSE ('0000')</td> <td>-</td> </tr> <tr> <td>Sn_MR_TCP ('0001')</td> <td>SOCK_INIT (0x13)</td> </tr> <tr> <td>Sn_MR_UDP ('0010')</td> <td>SOCK_UDP (0x22)</td> </tr> <tr> <td>SO_MR_MACRAW ('0100')</td> <td>SOCK_MACRAW (0x02)</td> </tr> </tbody> </table>	Sn_MR (P[3:0])	Sn_SR	Sn_MR_CLOSE ('0000')	-	Sn_MR_TCP ('0001')	SOCK_INIT (0x13)	Sn_MR_UDP ('0010')	SOCK_UDP (0x22)	SO_MR_MACRAW ('0100')	SOCK_MACRAW (0x02)
Sn_MR (P[3:0])	Sn_SR											
Sn_MR_CLOSE ('0000')	-											
Sn_MR_TCP ('0001')	SOCK_INIT (0x13)											
Sn_MR_UDP ('0010')	SOCK_UDP (0x22)											
SO_MR_MACRAW ('0100')	SOCK_MACRAW (0x02)											
0x02	LISTEN	<p>This is valid only in TCP mode (Sn_MR(P3:P0) = Sn_MR_TCP). In this mode, Socket n operates as a 'TCP server' and waits for connection-request (SYN packet) from any 'TCP client'.</p> <p>The Sn_SR changes the state from SOCK_INIT to SOCKET_LISTEN. When a 'TCP client' connection request is successfully established, the Sn_SR changes from SOCK_LISTEN to SOCK_ESTABLISHED and the Sn_IR(0) becomes '1'. But when a 'TCP client' connection request is failed, Sn_IR(3) becomes '1' and the status of Sn_SR changes to SOCK_CLOSED.</p>										
0x04	CONNECT	<p>This is valid only in TCP mode and operates when Socket n acts as 'TCP client'. To connect, a connect-request (SYN packet) is sent to 'TCP server' configured by Sn_DIPR & Sn_DPORT(destination address & port). If the connect-request is successful, the Sn_SR is changed to SOCK_ESTABLISHED and the Sn_IR(0) becomes '1'.</p> <p>The connect-request fails in the following three cases.</p> <ol style="list-style-type: none"> 1. When a ARP_{TO} occurs (Sn_IR(3)='1') because the destination hardware address is not acquired through the ARP-process. 2. When a SYN/ACK packet is not received and TCP_{TO} (Sn_IR(3) = '1') 3. When a RST packet is received instead of a SYN/ACK packet. 										

		In these cases, Sn_SR is changed to SOCK_CLOSED.
0x08	DISCON	<p>Valid only in TCP mode.</p> <p>Regardless of 'TCP server' or 'TCP client', the DISCON command processes the disconnect-process ('Active close' or 'Passive close').</p> <p>Active close: it transmits disconnect-request(FIN packet) to the connected peer</p> <p>Passive close: When FIN packet is received from peer, a FIN packet is replied back to the peer.</p> <p>When the disconnect-process is successful (that is, FIN/ACK packet is received successfully), Sn_SR is changed to SOCK_CLOSED. Otherwise, TCP_{TO} occurs (Sn_IR(3)='1')= and then Sn_SR is changed to SOCK_CLOSED.</p> <p>cf> If CLOSE is used instead of DISCON, only Sn_SR is changed to SOCK_CLOSED without disconnect-process.</p> <p>If a RST packet is received from a peer during communication, Sn_SR is unconditionally changed to SOCK_CLOSED.</p>
0x10	CLOSE	<p>Close Socket n.</p> <p>Sn_SR is changed to SOCK_CLOSED.</p>
0x20	SEND	SEND transmits all the data in the Socket n TX buffer. For more details, please refer to Socket n TX Free Size Register (Sn_TX_FSR), Socket n, TX Write Pointer Register(Sn_TX_WR), and Socket n TX Read Pointer Register(Sn_TX_RD).
0x21	SEND_MAC	<p>Valid only in UDP mode.</p> <p>The basic operation is same as SEND. Normally SEND transmits data after destination hardware address is acquired by the automatic ARP-process(Address Resolution Protocol). But SEND_MAC transmits data without the automatic ARP-process. In this case, the destination hardware address is acquired from Sn_DHAR configured by host, instead of APR-process.</p>
0x22	SEND_KEEP	<p>Valid only in TCP mode.</p> <p>It checks the connection status by sending 1byte keep-alive packet. If the peer cannot respond to the keep-alive packet during timeout time, the connection is terminated and the timeout interrupt will occur.</p>

0x40	RECV	<p>RECV completes the processing of the received data in Socket n RX Buffer by using a RX read pointer register (Sn_RX_RD).</p> <p>For more details, refer to Socket n RX Received Size Register (Sn_RX_RSR), Socket n RX Write Pointer Register (Sn_RX_WR), and Socket n RX Read Pointer Register (Sn_RX_RD).</p>
------	------	--

Sn_IR (Socket n Interrupt Register) [R] [0x0002] [0x00]

Sn_IR indicates the status of Socket Interrupt such as establishment, termination, receiving data, timeout). When an interrupt occurs and the corresponding bit of Sn_IMR is '1', the corresponding bit of Sn_IR becomes '1'.

In order to clear the Sn_IR bit, the host should write the bit to '1'.

7	6	5	4	3	2	1	0
Reserved	Reserved	Reserved	SEND_OK	TIMEOUT	RECV	DISCON	CON

Bit	Symbol	Description
7-5	Reserved	Reserved
4	SEND_OK	Sn_IR(SENDOK) Interrupt This is issued when SEND command is completed.
3	TIMEOUT	Sn_IR(TIMEOUT) Interrupt This is issued when ARP _{TO} or TCP _{TO} occurs.
2	RECV	Sn_IR(RECV) Interrupt This is issued whenever data is received from a peer.
1	DISCON	Sn_IR(DISCON) Interrupt This is issued when FIN or FIN/ACK packet is received from a peer.
0	CON	Sn_IR(CON) Interrupt This is issued one time when the connection with peer is successful and then Sn_SR is changed to SOCK_ESTABLISHED.

Sn_SR (Socket n Status Register) [R] [0x0003] [0x00]

Sn_SR indicates the status of Socket n. The status of Socket n is changed by Sn_CR or some special control packet as SYN, FIN packet in TCP.

Value	Symbol	Description
0x00	SOCK_CLOSED	This indicates that Socket n is released. When DICON, CLOSE command is ordered, or when a timeout occurs, it is changed to SOCK_CLOSED regardless of previous status.
0x13	SOCK_INIT	This indicates Socket n is opened with TCP mode. It is changed to SOCK_INIT when Sn_MR (P[3:0]) = '0001' and OPEN command is ordered. After SOCK_INIT, user can use LISTEN /CONNECT command.
0x14	SOCK_LISTEN	This indicates Socket n is operating as 'TCP server' mode and waiting for connection-request (SYN packet) from a peer ('TCP client'). It will change to SOCK_ESTABLISHED when the connection-request is successfully accepted. Otherwise it will change to SOCK_CLOSED after TCPTO occurred (Sn_IR(TIMEOUT) = '1').
0x17	SOCK_ESTABLISHED	This indicates the status of the connection of Socket n. It changes to SOCK_ESTABLISHED when the 'TCP SERVER' processed the SYN packet from the 'TCP CLIENT' during SOCK_LISTEN, or when the CONNECT command is successful. During SOCK_ESTABLISHED, DATA packet can be transferred using SEND or RECV command.
0x1C	SOCK_CLOSE_WAIT	This indicates Socket n received the disconnect-request (FIN packet) from the connected peer. This is half-closing status, and data can be transferred. For full-closing, DISCON command is used. But For just-closing, CLOSE command is used.
0x22	SOCK_UDP	This indicates Socket n is opened in UDP mode(Sn_MR(P[3:0]) = '0010'). It changes to SOCK_UDP when Sn_MR(P[3:0]) = '0010' and OPEN command is ordered. Unlike TCP mode, data can be transferred without the connection-process.

0x42	SOCK_MACRAW	<p>This indicates Socket 0 is opened in MACRAW mode (SO_MR(P[3:0]) = '0100') and is valid only in Socket 0.</p> <p>It changes to SOCK_MACRAW when SO_MR(P[3:0]) = '0100' and OPEN command is ordered.</p> <p>Like UDP mode socket, MACRAW mode Socket 0 can transfer a MAC packet (Ethernet frame) without the connection-process.</p>
------	-------------	--

The following table shows a temporary status indicated during changing the status of Socket n.

Value	Symbol	Description
0x15	SOCK_SYNSENT	<p>This indicates Socket n sent the connect-request packet (SYN packet) to a peer.</p> <p>It is temporarily shown when Sn_SR is changed from SOCK_INIT to SOCK_ESTABLISHED by CONNECT command.</p> <p>If connect-accept(SYN/ACK packet) is received from the peer at SOCK_SYNSENT, it changes to SOCK_ESTABLISHED.</p> <p>Otherwise, it changes to SOCK_CLOSED after TCPTO (Sn_IR[TIMEOUT] = '1') is occurred.</p>
0x16	SOCK_SYNRECV	<p>It indicates Socket n successfully received the connect-request packet (SYN packet) from a peer.</p> <p>If socket n sends the response (SYN/ACK packet) to the peer successfully, it changes to SOCK_ESTABLISHED. If not, it changes to SOCK_CLOSED after timeout occurs (Sn_IR[TIMEOUT] = '1').</p>
0x18	SOCK_FIN_WAIT	<p>These indicate Socket n is closing.</p>
0x1A	SOCK_CLOSING	<p>These are shown in disconnect-process such as active-close and passive-close.</p>
0x1B	SOCK_TIME_WAIT	<p>When Disconnect-process is successfully completed, or when timeout occurs, these change to SOCK_CLOSED.</p>
0x1D	SOCK_LAST_ACK	<p>This indicates Socket n is waiting for the response (FIN/ACK packet) to the disconnect-request (FIN packet) by passive-close.</p> <p>It changes to SOCK_CLOSED when Socket n received the response successfully, or when timeout occurs (Sn_IR[TIMEOUT] = '1').</p>

Sn_PORT (Socket n Source Port Register) [R/W] [0x0004-0x0005] [0x0000]

Sn_PORT configures the source port number of Socket n. It is valid when Socket n is used in TCP/UDP mode. It should be set before OPEN command is ordered.

Ex) In case of Socket 0 Port = 5000(0x1388), configure as below,

0x0004	0x0005
0x13	0x88

Sn_DHAR (Socket n Destination Hardware Address Register)

[R/W] [0x0006-0x000B] [0xFFFFFFFFFFFF]

Sn_DHAR configures the destination hardware address of Socket n when using SEND_MAC command in UDP mode or it indicates that it is acquired in ARP-process by CONNECT/SEND command.

Ex) In case of Socket 0 Destination Hardware address = 08.DC.00.01.02.10, configure as below.

0x0006	0x0007	0x0008	0x0009	0x000A	0x000B
0x08	0xDC	0x00	0x01	0x02	0x0A

SKY↑TECH

تهیه و توزیع قطعات الکترونیک

Sn_DIPR (Socket n Destination IP Address Register)

[R/W] [0x000C-0x000F] [0x00000000]

Sn_DIPR configures or indicates the destination IP address of Socket n. It is valid when Socket n is used in TCP/UDP mode.

In TCP client mode, it configures an IP address of 'TCP server' before CONNECT command.

In TCP server mode, it indicates an IP address of 'TCP client' after successfully establishing connection.

In UDP mode, it configures an IP address of peer to be received the UDP packet by SEND or SEND_MAC command.

Ex) In case of Socket 0 Destination IP address = 192.168.0.11, configure as below.

0x000C	0x000D	0x000E	0x000F
192 (0xC0)	168 (0xA8)	0 (0x00)	11 (0x0B)

Sn_DPORT (Socket n Destination Port Register) [R/W] [0x0010-0x0011] [0x00]

Sn_DPORT configures or indicates the destination port number of Socket n. It is valid when Socket n is used in TCP/UDP mode.

In TCP client mode, it configures the listen port number of 'TCP server' before CONNECT command.

In TCP server mode, it indicates the port number of 'TCP client' after successfully establishing connection.

In UDP mode, it configures the port number of peer to be transmitted the UDP packet by SEND/SEND_MAC command.

Ex) In case of Socket 0 Destination Port = 5000(0x1388), configure as below,

0x0010	0x0011
0x13	0x88

Sn_MSSR (Socket n Maximum Segment Size Register) [R/W] [0x0012-0x0013] [0x0000]

Sn_MSSR configures or indicates the MTU(Maximum Transfer Unit) of Socket n.

The default MTU is valid when Socket n is used in TCP / UDP mode. However, when in PPPoE mode(MR[PPPoE] = '1'), it is determined within PPPoE MTU.

Mode	Normal (MR(PPPoE)='0')		PPPoE (MR(PPPoE)='1')	
	Default MTU	Range	Default MTU	Range
TCP	1460	1 - 1460	1452	1 - 1452
UDP	1472	1 - 1472	1464	1 - 1464
MACRAW	1514			

When Socket n is used in MACRAW mode, the default MTU is applied because the MTU is not processed internally. Therefore, when transmitting the data bigger than default MTU, the host should manually divide the data into the unit of default MTU.

When Socket n is used in TCP/UDP mode, and transmitting data bigger than MTU, the data is automatically divided into the unit of MTU.

In UDP mode, because there is no such connection-process like in TCP mode, the configured MTU is used. When transmitting data to a peer with the different MTU size, the ICMP(Fragment MTU) packet might be received. In this case, IR(FMTU) becomes '1' and the peer information such as the MTU size and IP address is indicated from FMTUR and UIPR respectively. If IR[MTU] = '1', user cannot transmit data to the peer. To resume the communication with peer, do as followed.

1. Close the Socket n by CLOSE command.
2. Set Sn_MSS to the indicated MTU from FMTUR
3. Open the Socket n by OPEN command
4. Resume the communication with the peer.

Ex) In case of Socket 0 MSS = 1460 (0x05B4), configure as below,

0x0012	0x0013
0x05	0xB4

Sn_TOS (Socket n IP Type of Service Register) [R/W] [0x0015] [0x00]

Sn_TOS configures the TOS(Type Of Service field in IP Header) of Socket n.

It is set before OPEN command.

For more the details, refer to <http://www.iana.org/assignments/ip-parameters>.

Sn_TTL (Socket n TTL Register) [R/W] [0x0016] [0x80]

Sn_TTL configures the TTL(Time To Live field in IP header) of Socket n.

It is set before OPEN command.

For more the details, refer to <http://www.iana.org/assignments/ip-parameters>.

Sn_RXBUF_SIZE (Socket n RX Buffer Size Register) [R/W] [0x001E] [0x02]

Sn_RXBUF_SIZE configures the RX buffer block size of Socket n. Socket n RX Buffer Block size can be configured with 1,2,4,8, and 16 Kbytes. If a different size is configured, the data cannot be normally received from a peer.

Although Socket n RX Buffer Block size is initially configured to 2Kbytes, user can re-configure its size using Sn_RXBUF_SIZE. The total sum of Sn_RXBUF_SIZE cannot be exceed 16Kbytes. When exceeded, the data reception error is occurred.

When all Sn_RXBUF_SIZE have been configured, Socket n RX Buffer is allocated with the configured size in 16KB RX Memory and is assigned sequentially from Socket 0 to Socket 7.

Socket n RX Buffer Block can be accessible with the 16bits Offset Address ranged from 0x0000 to 0xFFFF regardless of the configured size. (Refer to Sn_RX_RD & Sn_RX_WR).

Value (dec)	0	1	2	4	8	16
Buffer size	0KB	1KB	2KB	4KB	8KB	16KB

Ex) Socket 0 RX Buffer Size = 8KB

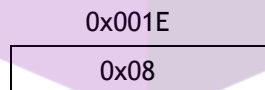

Sn_TXBUF_SIZE (Socket n TX Buffer Size Register) [R/W] [0x001F] [0x02]

Sn_TXBUF_SIZE configures the TX buffer block size of Socket n. Socket n TX Buffer Block size can be configured with 1,2,4,8, and 16 Kbytes. If a different size is configured, the data can't be normally transmitted to a peer.

Although Socket n TX Buffer Block size is initially configured to 2Kbytes, user can be re-configure its size using Sn_TXBUF_SIZE. The total sum of Sn_TXBUF_SIZE cannot be exceed 16Kbytes. When exceeded, the data transmission error is occurred.

When all Sn_TXBUF_SIZE have been configured, Socket n TX Buffer is allocated with the configured size in 16KB TX Memory and is assigned sequentially from Socket 0 to Socket 7.

Socket n TX Buffer Block can be accessible with 16bits Offset Address ranged from 0x0000 to 0xFFFF regardless of the configured size. (Refer to Sn_TX_WR & Sn_TX_RD).

Value (dec)	0	1	2	4	8	16
Buffer size	0KB	1KB	2KB	4KB	8KB	16KB

Ex) Socket 0 TX Buffer Size = 4KB

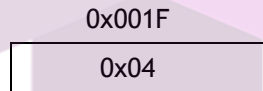

Sn_TX_FSR (Socket n TX Free Size Register) [R] [0x0020-0x0021] [0x0800]

Sn_TX_FSR indicates the free size of Socket n TX Buffer Block. It is initialized to the configured size by Sn_TXBUF_SIZE. Data bigger than Sn_TX_FSR should not be saved in the Socket n TX Buffer because the bigger data overwrites the previous saved data not yet sent. Therefore, check before saving the data to the Socket n TX Buffer, and if data is equal or smaller than its checked size, transmit the data with SEND/SEND_MAC command after saving the data in Socket n TX buffer. But, if data is bigger than its checked size, transmit the data after dividing into the checked size and saving in the Socket n TX buffer.

If Sn_MR(P[3:0]) is not TCP mode('0001'), it is automatically calculated as the difference between 'Socket n TX Write Pointer (Sn_TX_WR)' and 'Socket n TX Read Pointer (Sn_TX_RD)'.

If Sn_MR(P[3:0]) is TCP mode('0001'), it is automatically calculated as the difference between Sn_TX_WR and the internal ACK pointer which indicates the point of data is received already by the connected peer.

Ex) In case of 2048(0x0800) in S0_TX_FSR,

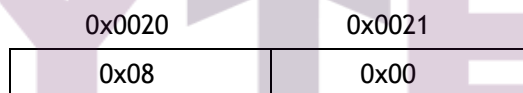

Sn_TX_RD (Socket n TX Read Pointer Register) [R] [0x0022-0x0023] [0x0000]

Sn_TX_RD is initialized by OPEN command. However, if Sn_MR(P[3:0]) is TCP mode('0001'), it is re-initialized while connecting with TCP.

After its initialization, it is auto-increased by SEND command. SEND command transmits the saved data from the current Sn_TX_RD to the Sn_TX_WR in the Socket n TX Buffer. After transmitting the saved data, the SEND command increases the Sn_TX_RD as same as the Sn_TX_WR. If its increment value exceeds the maximum

value 0xFFFF, (greater than 0x10000 and the carry bit occurs), then the carry bit is ignored and will automatically update with the lower 16bits value.

Sn_TX_WR (Socket n TX Write Pointer Register) [R/W] [0x0024-0x0025] [0x0000]

Sn_TX_WR is initialized by OPEN command. However, if Sn_MR(P[3:0]) is TCP mode('0001'), it is re-initialized while connecting with TCP.

It should be read or to be updated like as follows.

1. Read the starting address for saving the transmitting data.
2. Save the transmitting data from the starting address of Socket n TX buffer.
3. After saving the transmitting data, update Sn_TX_WR to the increased value as many as transmitting data size. If the increment value exceeds the maximum value 0xFFFF(greater than 0x10000 and the carry bit occurs), then the carry bit is ignored and will automatically update with the lower 16bits value.
4. Transmit the saved data in Socket n TX Buffer by using SEND/SEND command

Sn_RX_RSR (Socket n Received Size Register) [R] [0x0026-0x0027] [0x0000]

Sn_RX_RSR indicates the data size received and saved in Socket n RX Buffer. Sn_RX_RSR does not exceed the Sn_RXBUF_SIZE and is calculated as the difference between 'Socket n RX Write Pointer (Sn_RX_WR)' and 'Socket n RX Read Pointer (Sn_RX_RD)'.

Ex) In case of 2048(0x0800) in S0_RX_RSR,

0x0026	0x0027
0x08	0x00

Sn_RX_RD (Socket n RX Read Data Pointer Register) [R/W] [0x0028-0x0029] [0x0000]

Sn_RX_RD is initialized by OPEN command. Make sure to be read or updated as follows.

1. Read the starting save address of the received data
2. Read data from the starting address of Socket n RX Buffer.
3. After reading the received data, Update Sn_RX_RD to the increased value as many as the reading size. If the increment value exceeds the maximum value 0xFFFF, that is, is greater than 0x10000 and the carry bit occurs, update with the lower 16bits value ignored the carry bit.
4. Order RECV command is for notifying the updated Sn_RX_RD to W5500.

Ex) In case of 2048(0x0800) in S0_RX_RD,

0x0028	0x0029
0x08	0x00

Sn_RX_WR (Socket n RX Write Pointer Register) [R] [0x002A-0x002B] [0x0000]

Sn_RX_WR is initialized by OPEN command and it is auto-increased by the data reception.

If the increased value exceeds the maximum value 0xFFFF, (greater than 0x10000 and the carry bit occurs), then the carry bit is ignored and will automatically update with the lower 16bits value.

Ex) In case of 2048(0x0800) in S0_RX_WR,

0x002A	0x002B
0x08	0x00

Sn_IMR (Socket n Interrupt Mask Register) [R/W] [0x002C] [0xFF]

Sn_IMR masks the interrupt of Socket n. Each bit corresponds to each bit of Sn_IR. When a Socket n Interrupt is occurred and the corresponding bit of Sn_IMR is '1', the corresponding bit of Sn_IR becomes '1'. When both the corresponding bit of Sn_IMR and Sn_IR are '1' and the n-th bit of IR is '1', Host is interrupted by asserted INTn PIN to low.

7	6	5	4	3	2	1	0
Reserved	Reserved	Reserved	SEND_OK	TIMEOUT	RECV	DISCON	CON

Bit	Symbol	Description
7-5	Reserved	Reserved
4	SENDOK	Sn_IR(SENDOK) Interrupt Mask
3	TIMEOUT	Sn_IR(TIMEOUT) Interrupt Mask
2	RECV	Sn_IR(RECV) Interrupt Mask
1	DISCON	Sn_IR(DISCON) Interrupt Mask
0	CON	Sn_IR(CON) Interrupt Mask

Sn_FRAG (Socket n Fragment Register) [R/W] [0x002D-0x002E] [0x4000]

Sn_FRAG configures the FRAG(Fragment field in IP header).

Ex) Sn_FRAG0 = 0x0000 (Don't Fragment)

0x002D	0x002E
0x00	0x00

Sn_KPALVTR (Socket n Keep Alive Time Register) [R/W] [0x002F] [0x00]

Sn_KPALVTR configures the transmitting timer of 'KEEP ALIVE(KA)' packet of SOCKETn. It is valid only in TCP mode, and ignored in other modes. The time unit is 5s.

KA packet is transmittable after Sn_SR is changed to SOCK_ESTABLISHED and after the data is transmitted or received to/from a peer at least once. In case of 'Sn_KPALVTR > 0', W5500 automatically transmits KA packet after time-period for checking the TCP connection (Auto-keepalive-process). In case of 'Sn_KPALVTR = 0', Auto-keep-alive-process will not operate, and KA packet can be transmitted by SEND_KEEP command by the host (Manual-keep-alive-process). Manual-keep-alive-process is ignored in case of 'Sn_KPALVTR > 0'.

Ex) Sn_KPALVTR = 10 (Keep Alive packet will be transmitted every 50 seconds.)

0x002F
0x0A

SKYTECH

تهیه و توزیع قطعات الکترونیک

5 Electrical Specifications

5.1 Absolute Maximum Ratings

Symbol	Parameter	Rating	Unit
V _{DD}	DC Supply voltage	-0.5 to 4.6	V
V _{IN}	DC input voltage	-0.5 to 6	V
V _{OUT}	DC output voltage	-0.5 to 4.6	V
I _{IN}	DC input current	±5	mA
T _{OP}	Operating temperature	-40 to +85	°C
T _{STG}	Storage temperature	-65 to +150	°C

***COMMENT:** Stressing the device beyond the 'Absolute Maximum Ratings' may cause permanent damage.

5.2 Absolute Maximum Ratings (Electrical Sensitivity)

Electrostatic discharge (ESD)

Symbol	Parameter	Test Condition	Class	Maximum value(1)	Unit
VESD(HBM)	Electrostatic discharge voltage (human body model)	TA = +25 °C conforming to MIL-STD 883F Method 3015.7	2	2000	V
VESD(MM)	Electrostatic discharge voltage (man machine model)	TA = +25 °C conforming to JEDEC EIA/ JESD22 A115-A	B	200	V
VESD(CDM)	Electrostatic discharge voltage (charge device model)	TA = +25 °C conforming to JEDEC JESD22 C101-C	III	500	V

Static latchup

Symbol	Parameter	Test Condition	Class	Maximum value(1)	Unit
LU	Static latch-up class	TA = +25 °C conforming to JESD78A	I	≥ ±200	mA

5.3 DC Characteristics

(Test Condition: $T_a = -40$ to 85°C)

Symbol	Parameter	Test Condition	Min	Typ	Max	Unit
V_{DD}	Supply voltage	Apply VDD, AVDD	2.97	3.3	3.63	V
V_{IH}	High level input voltage		2.0		5.5	V
V_{IL}	Low level input voltage		- 0.3		0.8	V
V_T	Threshold point	All inputs except XI	1.30	1.41	1.53	V
V_{T+}	Schmitt trig Low to High Threshold point	All inputs except XI	1.53	1.64	1.73	V
V_{T-}	Schmitt trig High to Low Threshold point	All inputs except XI	0.95	1.02	1.09	V
T_J	Junction temperature		0	25	125	$^\circ\text{C}$
I_L	Input Leakage Current				± 1	μA
R_{PU}	Pull-up Resistor	SCSn, RSTn, PMODE[2:0]	62	77	112	Kohm
R_{PD}	Pull-down Resistor	RSVD(Pin 23, Pin 38 ~ Pin 42)	48	85	174	Kohm
V_{OL}	Low level output voltage	$I_{OL} = 8\text{mA}$, All outputs except XO			0.4	V
V_{OH}	High level output voltage	$I_{OH} = 8\text{mA}$, All outputs except XO	2.4			V
I_{OL}	Low level output Current	$V_{OL} = 0.4\text{V}$, All outputs except XO	8.6	13.9	18.9	mA
I_{OH}	High level output Current	$V_{OH} = 2.4\text{V}$, All outputs except XO	12.5	26.9	47.1	mA
I_{DD1}	Supply Current (Normal operation mode)	$V_{DD}=3.3\text{V}$, $AV_{DD}=3.3\text{V}$, $T_a = 25^\circ\text{C}$		132		mA
I_{DD2}	Supply Current (Power Down mode)	PHY Power Down mode, $V_{DD}=3.3\text{V}$, $AV_{DD}=3.3\text{V}$, $T_a = 25^\circ\text{C}$		13		mA

5.4 Power Dissipation

(Test Condition: VDD=3.3V, AVDD=3.3V, Ta = 25 °C)

Condition	Min	Typ	Max	Unit
100M Link	-	128	-	mA
10M Link	-	75	-	mA
Un-Link (Auto-negotiation mode)	-	65	-	mA
100M Transmitting	-	132	-	mA
10M Transmitting	-	79	-	mA
Power Down mode	-	13	-	mA

5.5 AC Characteristics

5.5.1 Reset Timing

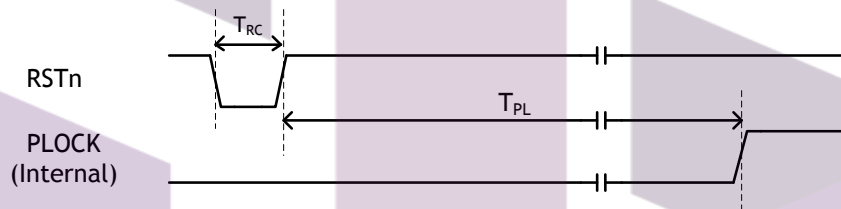

Figure 22. Reset Timing

Symbol	Description	Min	Max
T _{RC}	Reset Cycle Time	500 us	-
T _{PL}	RSTn to internal PLOCK (PLL Lock)	-	1 ms

5.5.2 Wake up Time

Voltage Regulator Wake up Time: 10us

5.5.3 Crystal Characteristics

Parameter	Range
Frequency	25 MHz
Frequency Tolerance (at 25 °C)	±30 ppm
Shunt Capacitance	7pF Max
Drive Level	59.12uW/MHz
Load Capacitance	18pF
Aging (at 25 °C)	±3ppm / year Max

5.5.4 SPI Timing

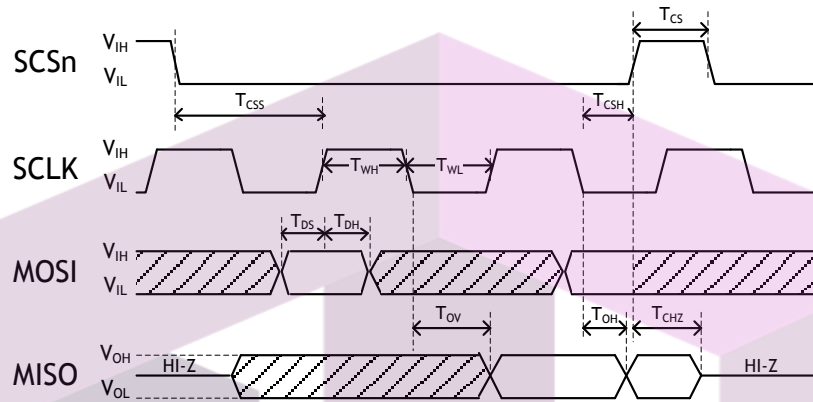

Figure 23. SPI Timing

Symbol	Description	Min	Max	Units
F_{SCK}	SCK Clock Frequency		80/33.3 ⁴	MHz
T_{WH}	SCK High Time	6		ns
T_{WL}	SCK Low Time	6		ns
T_{CS}	SCSn High Time	30		ns
T_{CSS}	SCSn Setup Time	5	-	ns
T_{CSH}	SCSn Hold Time	5		ns
T_{DS}	Data In Setup Time	3		ns
T_{DH}	Data In Hold Time	3		ns
T_{OV}	Output Valid Time		5	ns
T_{OH}	Output Hold Time	0		ns
T_{CHZ}	SCSn High to Output Hi-Z		2.1 ⁵	ns

⁴ Theoretical Guaranteed Speed

Even though theoretical design speed is 80MHz, the signal in the high speed may be distorted because of the circuit crosstalk and the length of the signal line. The minimum guaranteed speed of the SCLK is 33.3 MHz which was tested and measured with the stable waveform.

Please refer to the SPI Application Note which shows the WIZnet test environment and results.

⁵ 2.1ns is when pn loaded with 30pF. The time is shorter with lower capacitance.

5.5.5 Transformer Characteristics

Parameter	Transmit End	Receive End
Turn Ratio	1:1	1:1
Inductance	350 uH	350 uH

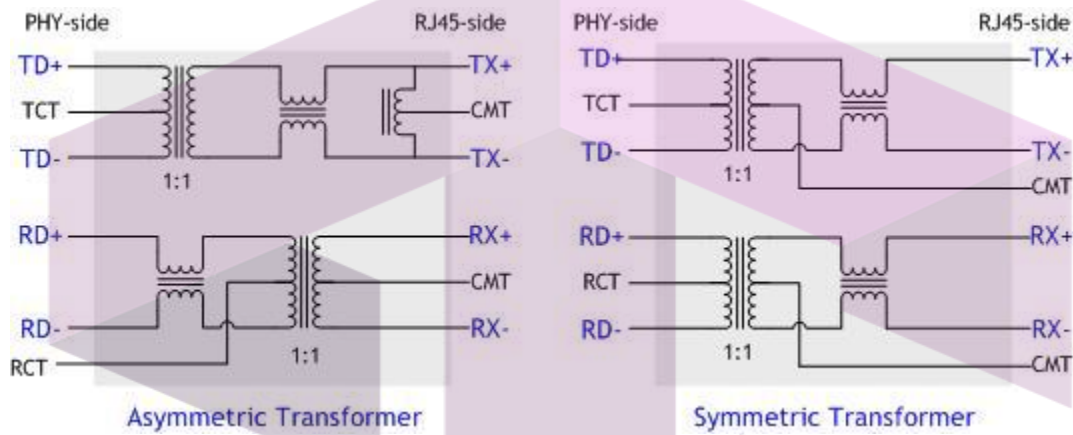

Figure 24. Transformer Type

5.5.6 MDIX

W5500 does not support auto-MDIX feature.

Thus, user should use straight-through cables to connect to other switches or routers and crossover cables to connect to devices such as servers, workstations or another W5500.

However, user can use either type of cable to connect to other devices with auto-MDIX enabled, and the interface automatically corrects for any incorrect cabling.

SKYTECH

تهیه و توزیع قطعات الکترونیک

6 Package Descriptions

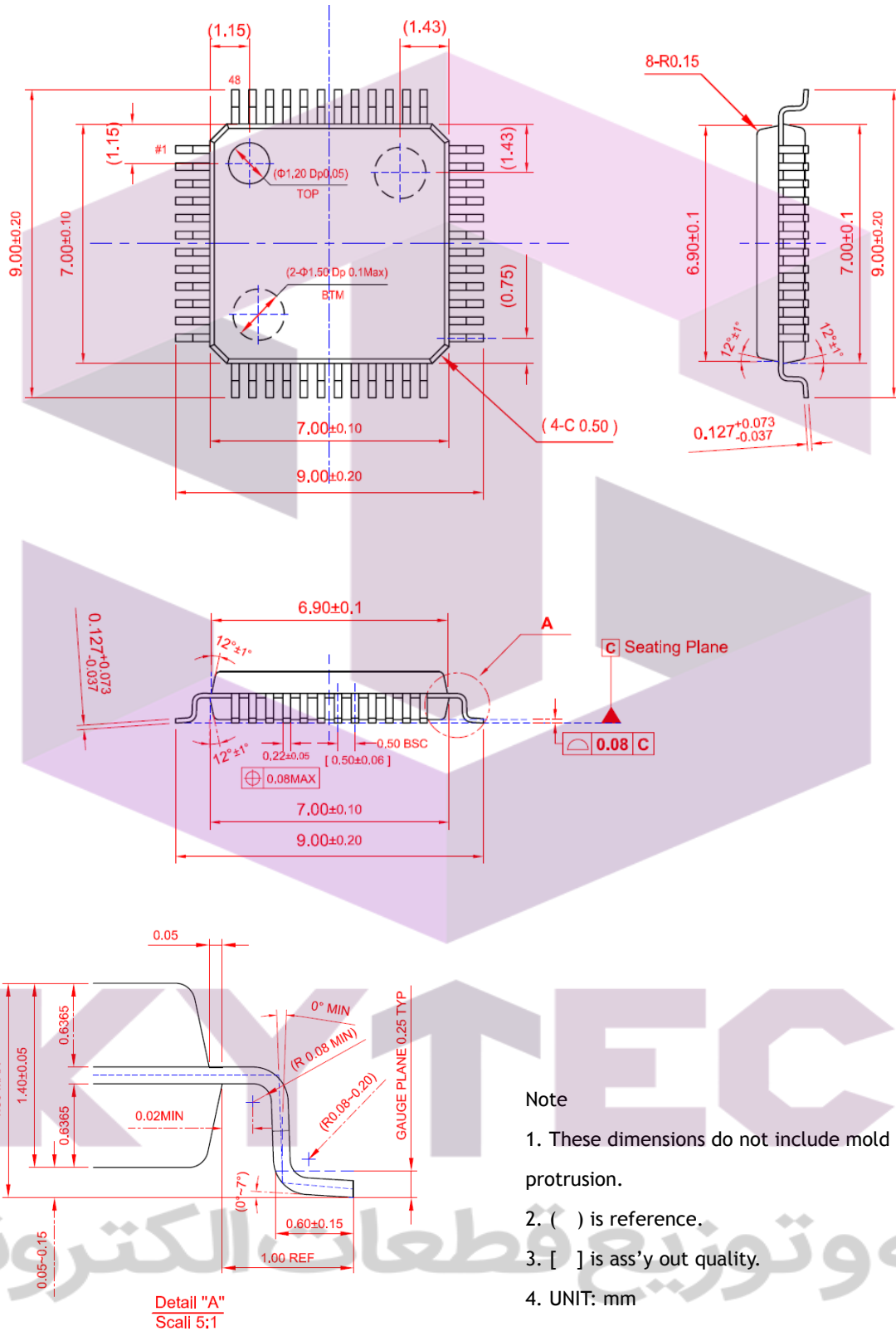

Note

1. These dimensions do not include mold protrusion.
2. () is reference.
3. [] is ass'y out quality.
4. UNIT: mm

Figure 25. Package Dimensions

Document History Information

Version	Date	Descriptions
Ver. 1.0.0	1AUG2013	Initial Release
Ver. 1.0.1	13SEP2013	Corrected duplicated statements and typing errors (P.14, 23, 24, 28, 39, 51) Corrected descriptions (P.35)
Ver. 1.0.2	14NOV2013	1. Changed “descriptions of pin at 1.1 Pin Descriptions”(P.10) from It must be tied to GND to NC(PIN38-42) 2. Corrected typing error : from 0x02 to 0x42 value of SOCK_MACRAW at 4.2 Socket Registers(P.50)

SKYTECH

تهیه و توزیع قطعات الکترونیک

Copyright Notice

Copyright 2013 WIZnet Co., Ltd. All Rights Reserved.

Technical Support: support@wiznet.co.kr

Sales & Distribution: sales@wiznet.co.kr

For more information, visit our website at <http://www.wiznet.co.kr>



SKYYTECH

تهیه و توزیع قطعات الکترونیک